

WAVELENGTH
ELECTRONICS

Catalog

High Performance Semiconductor Laser Control Electronics
from Bozeman, MT USA, founded in 1993

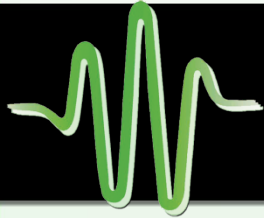



Researchers:

Start with stable wavelength, stable power, stable current, and stable temperature to successfully complete groundbreaking, innovative research with easy-to-use touchscreen instruments and exceptional tech support.

Developers & Engineers:

Partner with us to successfully complete strategic project releases at lower risk through standard product, engineering expertise, and responsive tech support

Manufacturers:

Release the final product quickly and successfully.

- Product Variations to minimize COGS & error-proof the manufacturing process
- Ongoing engineering support for FDA or UL approved systems, handling obsolete components.

Then we deliver. Consistently. On time. Handling supply chain risk.

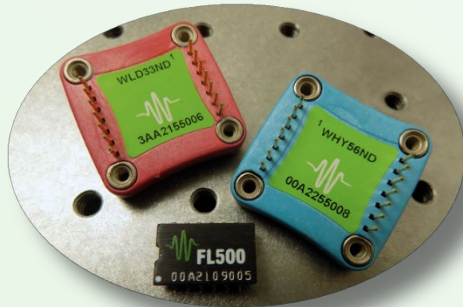
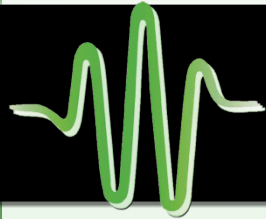

SPI
I²C
USB
Ethernet

Laser Diode Drivers

CW to 3MHz bandwidth
1mA to >15A output current
2V to >85V compliance voltage
LEDs, VCSELs, SLEDs

Temperature Controllers

0.0009°C stability
2A to >10A output current
Digital or analog PID control
Intellitune® dynamic control automation

QCL Drivers

Patented low noise driver
0.4 to 2.3 μ A RMS
1 to 4 nA/ $\sqrt{\text{Hz}}$ current noise density
OEM & Touchscreen instruments

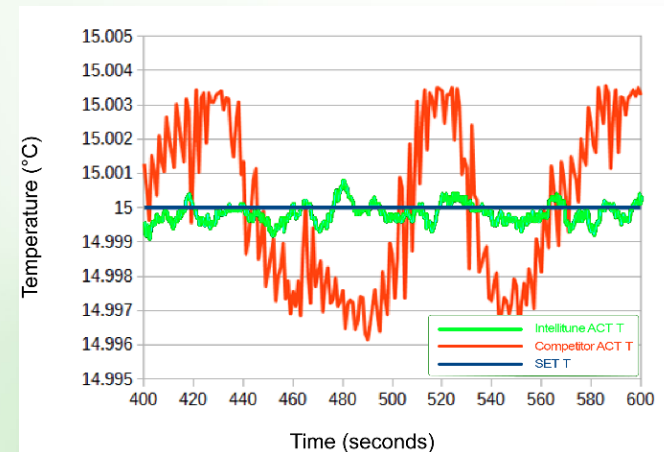



LDTC LAB Instrument

FEATURES

- Output Current 5A Laser & ± 10 A TEC
- Compliance Voltage 10V Laser & 15V TEC
- Compatible with most sensor types and all LD/PD combinations
- Temperature stability better than 0.0009°C
- Laser cumulative current noise of $16\ \mu\text{A RMS}$
- Modulation input bandwidth of 450 kHz (CC mode)
- Intuitive user interface touchscreen
- Adjustable current limits, over- and under-temperature protection
- IntelliTune[®] sets ideal temperature control parameters for optimal time to temperature or disturbance rejection
- Complete command set for remote control from computer



Size: 17.7 x 8.9 x 3.5 in (450 x 225 x 88 mm)



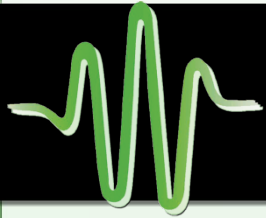

LDTC LAB Instrument

SPECIFICATIONS

PARAMETER	LD2TC5	LD5TC10	UNIT	NOTES
LASER DIODE DRIVER				
Compliance Voltage	10		V	
Maximum Output Current	2	5	A	
RMS Noise Current	7	16	μ A RMS	Measured from 1 Hz to 100 kHz
TEMPERATURE CONTROLLER				
Compliance Voltage	15		V	
Maximum Output Current	5	10	A	
Short Term Stability	0.0009		$^{\circ}$ C	Measured over 1 hour

ULTRA-STABLE TEMPERATURE CONTROLLER & LOW-NOISE LASER DRIVER

The **LDTC LAB Series** instruments combine best-in-class low noise, high-end digital control laser diode driver technology with an IntelliTune® smart temperature controller. If you need stable wavelength, stable temperature (better than 0.0009° C with thermistors), stable laser diode current or power, or low noise (RMS laser driver noise as low as 7μ A), these offer the best performance and value.

Two models are available, the LD2TC5 LAB and the LD5TC10 LAB. The LD2TC5 LAB outputs up to 2 and 5 A for the laser and thermoelectric, respectively. The LD5TC10 LAB outputs up to 5 and 10 A. Both models offer 10 V of laser compliance voltage and 15 V of thermoelectric compliance voltage.

INTUITIVE USER INTERFACE AND SUPERIOR SOFTWARE CONTROL

The touch-screen interface makes operation intuitive and simple. A LabVIEW® virtual instrument, remote command set, and USB interface allow integration into an instrument library.



TC LAB Instrument

FEATURES

- Temperature stability better than 0.0009°C
- Compatible with Thermistors, 2-, 3-, or 4-wire RTDs, Linear voltage sensors, Linear current sensors
- Touchscreen with intuitive user interface
- Adjustable current limit, with Brick-Wall Never-Exceed circuitry
- Password protection available to lock out a selectable control set
- Over-temperature protection circuit
- Temperature limits on the load
- Shutdown signal to the QCL/laser driver load to protect against over or under temperature situations.
- IntelliTune[®] sets ideal control parameters for optimal time to temperature or disturbance rejection
- Complete command set for remote control from computer
- LabVIEW[™] Virtual Instrument interface
- AC input $115/230 \pm 15\%$ VAC 50/60 Hz



Size: 17.7 x 8.9 x 3.5 in (450 x 225 x 88 mm)



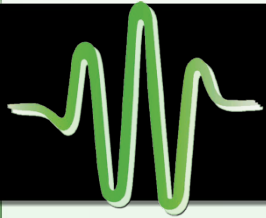

TC LAB Instrument

TEMPERATURE CONTROLLER SPECIFICATIONS

DRIVER OUTPUT CURRENT	MIN	TYP	MAX	UNIT	NOTE
Output Current	5, 10, or 15			A	5 A for TC5 LAB, 10 A for TC10 LAB, 15 A for TC15 LAB
Compliance Voltage	0-15 or 0-20			V	≤15 V for TC5 LAB and TC10 LAB, ≤20 V for TC15 LAB
Stability, 1 Hour	0.0009			°C	25°C Ambient, On Ambient
Stability, 24 Hours	0.002			°C	25°C Ambient, Off Ambient
Temperature Coefficient	5	10	18	ppm / °C	

ULTRA-STABLE TEMPERATURE CONTROLLER

The TC LAB series of temperature controllers integrates high-end Digital Control with a precision output current drive stage to offer better than 0.0009°C temperature stability. Many different sensors can be used in the feedback loop.

Models are available driving 5 A or 10 A maximum with 15 V compliance or 15 A maximum with 20 V compliance to the thermoelectric or resistive heater. Safety features protect the thermoelectric [TE] and its load. Over and under temperature limits as well as positive and negative current limits can be set. If the sensor signal is lost or a short is detected at the TE, output current is disabled. If temperature limits are exceeded, a signal to the active load can be sent to disable its current.

INTUITIVE USER INTERFACE AND SUPERIOR SOFTWARE CONTROL

With Wavelength's plug and play instrument, you have the ability to quickly set the controls using either the instrument touchscreen or a remote computer.

INTELLITUNE

Instead of long, manual calculations to derive the optimal Proportional, Integral, and Derivative [PID] control terms for a load, press the IntelliTune icon to characterize the load. IntelliTune automatically responds to changes in setpoint or tuning goals, optimizing PID control.



QCL LAB Instrument

FEATURES

Output current of 500 mA, 1 A, 1.5 A, or 2 A

Low noise: $< 0.4 \mu\text{A RMS}$ up to 100 kHz (typical)

Compliance voltage up to 20 V

USB and Ethernet interfaces with LabVIEW™ VI

5 V output for alignment LED

CE compliant, compatible with CDRH laser regulations

All software and instrument documentation provided on a USB flash drive

Optional rack mount kit: 2 U height, $\frac{1}{2}$ rack width

AC input switch selectable from 115/230 $\pm 15\%$ VAC with a 50/60 Hz power-line frequency

Safety features protect your QCL investment

- Adjustable soft-clamp current limit, with Brick-Wall Never-Exceed circuitry
- Driver over-temperature protection circuit



Size: 17.7 x 8.9 x 3.5 in (450 x 225 x 88 mm)

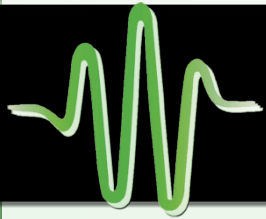

QCL LAB Instrument

INTUITIVE USER INTERFACE

With Wavelength's plug and play instrument, you have the ability to quickly set the controls using the instrument touchscreen - Setpoint, Limit Current, Supply Voltage, Cable Resistance, and more.

CONTROL THE INSTRUMENT VIA REMOTE COMPUTER

The QCL Laboratory Series instruments can be controlled remotely from a computer using a LabVIEW™ virtual instrument application or the remote command set.

APPLICATIONS

Due to their unique construction, QCLs operate with high power in the near-IR through terahertz ranges. These wavelengths are particularly suited to detection of molecules significant to humans. Applications include: remote detection of explosive materials, medical diagnosis using the breath, non-invasive glucose testing, emissions monitoring, and pharmaceutical process quality control, anesthesia and hospital air quality monitoring, leak detection, and remote imaging.

SPECIFICATIONS

PARAMETER	MIN	TYP	MAX	UNIT
Compliance Voltage			20	V
Max Output Current	0.5, 1.0, 1.5, 2.0			A
RMS Noise Current	0.4	1	1.3	μA RMS
Noise Current Density	1	2	4	nA / √Hz
Long Term Stability, 24 hr	5	10	15	ppm
Temperature Coefficient	5	10	18	ppm / °C
Modulation Bandwidth (sinewave)		2	3	MHz
Rise Time / Fall Time	250 / 200			nsec

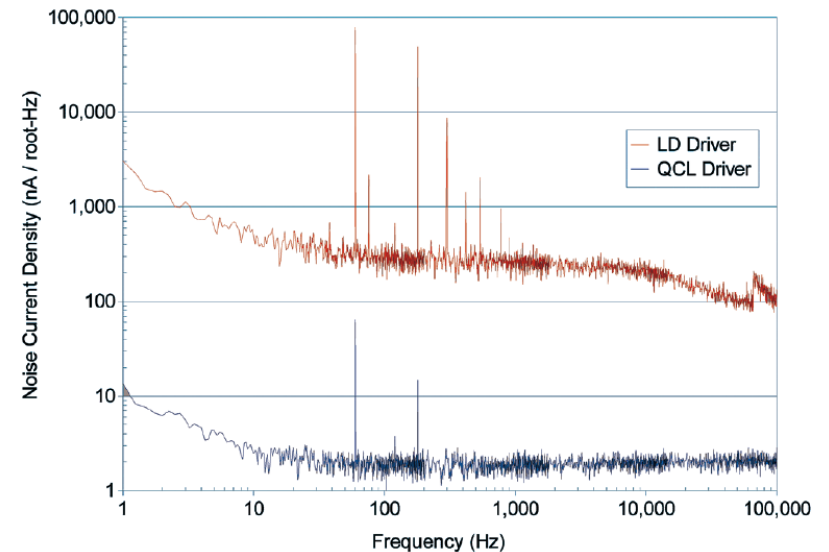

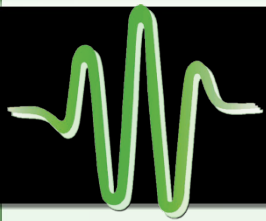

QCL OEM Module

FEATURES

Output current of 500 mA, 1 A, 1.5 A, or 2 A

Low noise: $< 0.4 \mu\text{A RMS}$ up to 100 kHz (typical)

Compliance voltage up to 20 V

Feature-rich for OEM applications

- On-board power and enable switches
- Analog current setpoint input
- TTL-compatible Power-On & Output Enable
- Status outputs can drive front-panel LEDs
- Optional 5 V output drives alignment LEDs
- Small Package 6.55" x 5.5" x 2.3"

± 24 VDC power supply required

Adjustable soft-clamp current limit, with Brick-Wall Never-Exceed circuitry

Brown-out, reverse-voltage, & over-voltage protection

Reverse polarity models available: QCL OEM(+)



Size: 5.5 x 6.55 x 2.3 in (140 x 166 x 59 mm)

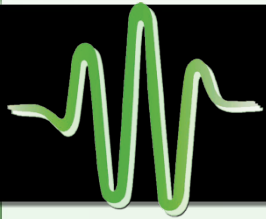

QCL OEM Module

LOW NOISE FOR ULTRA-NARROW LINEWIDTHS

Two key characteristics of quantum cascade lasers make them popular for precision sensing and spectroscopy applications: 1) the wavelength can be custom-tailored to mid- and long-wavelength IR, and 2) the extremely narrow linewidth allows for faster, higher-precision, and more repeatable measurements than competing technologies.

Laser emission wavelength and linewidth are both partly a function of current density, and therefore drive current noise and jitter manifest directly as broadened linewidth and wavelength jitter. Broadening the center wavelength by a fraction of a cm^{-1} can reduce measurement sensitivity by an order of magnitude or more, so it is critical to eliminate electronic noise.

ULTRA-STABLE OUTPUT CURRENT

With trace gas and chemical detection systems, overall repeatability hinges on the stability of the current source. The QCL achieves stability on the order of ± 10 ppm over 1 hour, tested with the unit on a bench and subject to ambient temperature fluctuations. The QCL driver maintains this level of stability even over a 24-hour test cycle.

SPECIFICATIONS

PARAMETER	MIN	TYP	MAX	UNIT
Driver Supply Voltage, Bipolar	± 22		± 25	VDC
Compliance Voltage	11 *	16	20 *	V
Max Output Current	0.5, 1.0, 1.5, 2.0			A
RMS Noise Current	0.4	1	1.3	$\mu\text{A RMS}$
Noise Current Density	1	2	4	$\text{nA} / \sqrt{\text{Hz}}$
Long Term Stability, 24 hr	5	10	15	ppm
Temperature Coefficient	5	10	18	$\text{ppm} / ^\circ\text{C}$
Modulation Bandwidth (sinewave)		2	3	MHz
Rise Time / Fall Time	250 / 200			nsec

* Ask for Product Variation PV055 for 20 V compliance or PV048 for the 11 V option.

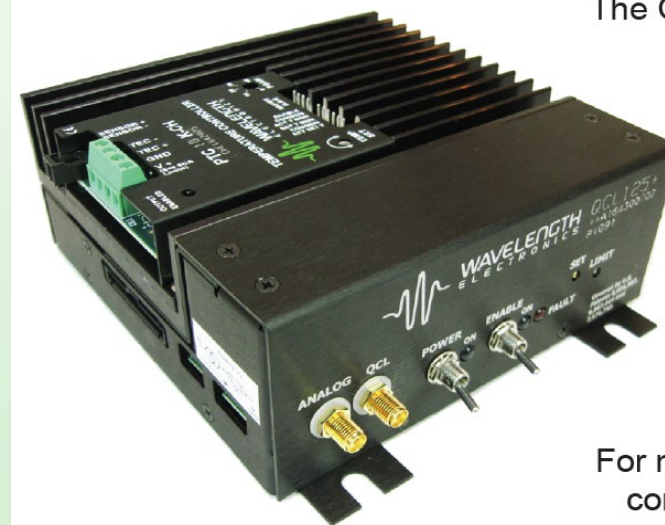

The QCL is available with integrated temperature control. This hybrid unit pairs a PTC10K-CH with a QCL OEM module.

For more information contact the factory.



LDxCHA Series Laser Diode Driver

FEATURES

Models: 2.5 A, 5 A, 10 A, and 15 A

Single supply operation at +5 VDC for single emitters (3 V maximum to laser)

Dual supply operation up to +30 VDC (28 V maximum to laser)

Constant Current or Constant Power modes

Safety features protect your laser

- » Adjustable clipping current limit
- » Slow-start and delay circuitry
- » Brownout protection
- » Over-voltage protection

Bandwidth 280 kHz to 1 MHz in Constant Current mode (model dependent)

RMS Noise Current as low as 7 μ A at 100 kHz

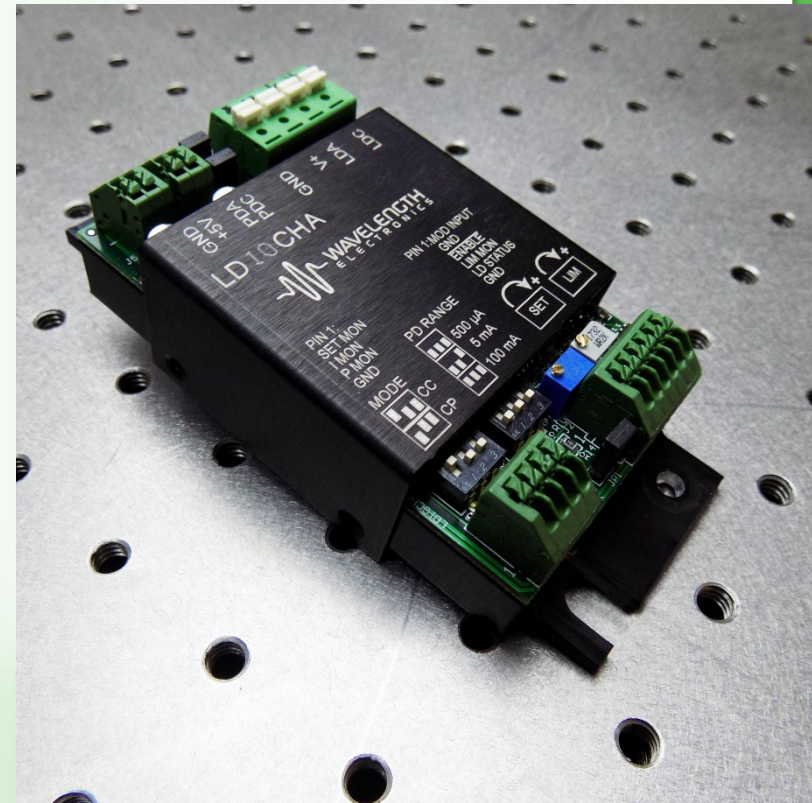

Size: 1.125 x 2.1 x 4.5 in (28.6 x 53.3 x 114.3 mm)

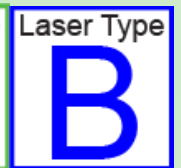
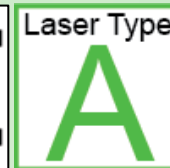



LDxCHA Series Laser Diode Driver

MEETING LASER REQUIREMENTS

The LDxCHA product family has current levels from 2.5 A up to 15 A. These drivers meet laser compliance requirements from 3 V with a single +5 V supply, and up to 28 V with an additional 30 V power supply, supporting applications such as materials processing, industrial laser cutting, and laser diode bars/stacks. This product family supports A & B type laser diodes.

WORRY-FREE SETUP

The new circuitry in the LDxCHA allows for the laser diode current limit and the laser diode current setpoint to be fine-tuned without output current enabled to the laser. This allows users to set the specific safety and output levels required without risk of overdriving the laser during initial configuration.

DESIGNED FOR EASY INTEGRATION

The LDxCHA drivers, with their small size and easy mountability, can be attached directly to an optics table or designed into a system. Two trimpots set the current limit and current setpoint, while five spring loaded terminal blocks allow for simple wiring.

LASER SAFETY FEATURES

Built-in safety features ensure robust designs for real world operating conditions: clipping current limit ensures that the output current will never exceed the setpoint; and slow start circuit ramps the output current. Long-term reliability means better up-time, fewer service calls, and more satisfied customers.

LDXCHA LASER DIODE DRIVER SPECIFICATIONS

PARAMETER	LD2.5CHA	LD5CHA	LD10CHA	LD15CHA	UNIT	NOTE
Max Output Current	2.5	5	10	15	A	
Max Internal Power Dissipation (with airflow)	35	35	70	85	W	25°C ambient 5.5 CFM: 2.5, 5 A models 12CFM: 10, 15 A models
Compliance Voltage	3 V max with 5 V power supply input 28 V max with 30 V power supply input				V	Always 2 V less than power supply voltage
Short Term Stability, 1hr	< 200				ppm	Constant Current Mode
Constant Power Mode Output Stability	0.14	0.27	0.03	0.03	%	200 µA photodiode range, simulated load
RMS Noise Current	7	9	22	35	µA	100 kHz, 500 mA output current
Noise Current Density	20	35	95	100	nA / √Hz	500 mA output current
Leakage Current	0				µA	
Quiescent Current	130				mA	
Temperature Coefficient	100				ppm / °C	
Bandwidth at 90% Depth of Modulation	1000	430	360	280	kHz	Constant Current Mode Half of maximum output current



PLD-CH Series Laser Driver

FEATURES

- Models driving up to 5 A, 10 A, or 12.5 A
- Single 5 V supply operation up to 10 A
- Compliance voltage up to 28 VDC with separate power supply
- Slow-start laser diode protection
- Constant Current or Constant Power mode
- Latching current limit
- Mechanical relay protection
- Remote Enable / Disable pin
- Onboard setpoint and limit trimpots
- Parallel two units to drive up to 25 A

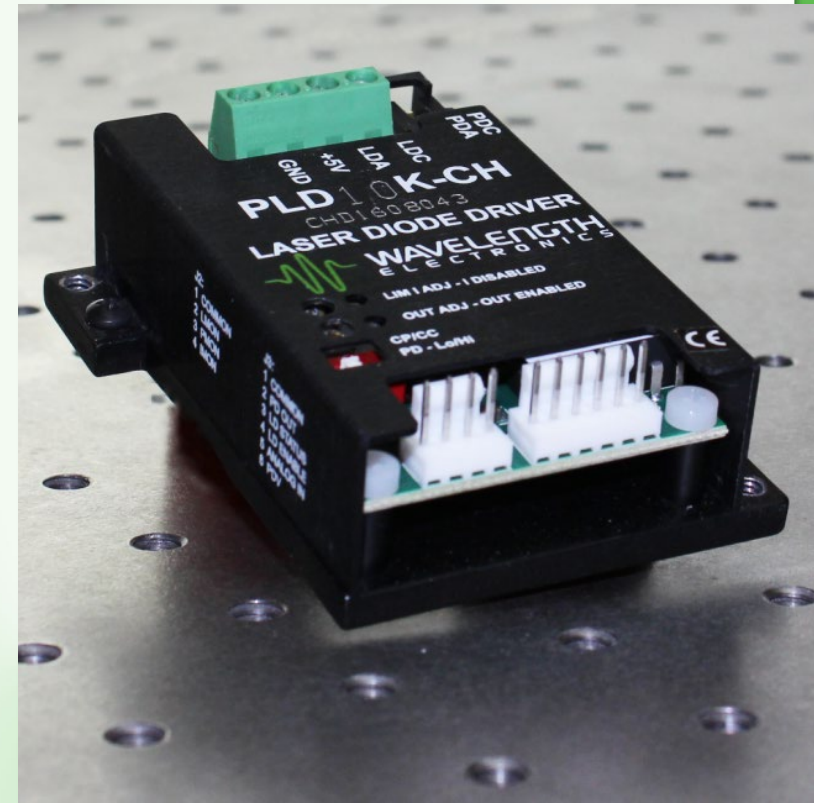

Size: 2.9 x 2.4 x 1.1 in (74 x 60 x 28 mm)

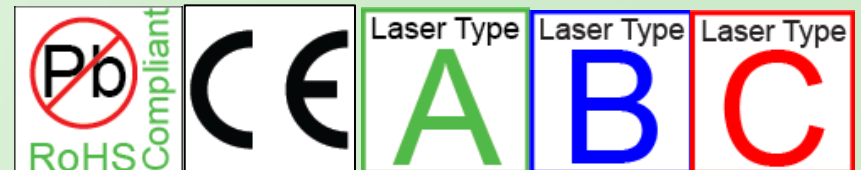

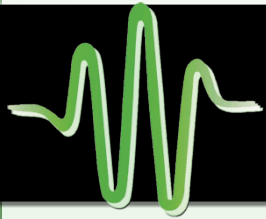

PLD-CH Series Laser Driver

CHASSIS-MOUNT FLEXIBILITY

The compact PLD-CH Series are our most popular laser diode controllers. The mount-anywhere modular package style and cabled connections give you the flexibility to place the laser driver at the ideal location within your system chassis.

Using a single 5 VDC power supply you can drive lasers up to 3 V compliance. Lasers with higher compliance voltage—up to 28 V—can be accommodated by using separate supplies for the laser and electronics.

The photodiode feedback input range is selectable in order to maximize control sensitivity, and the outstanding constant power stability makes this high-power driver ideal for industrial applications where continuous stable laser output power is required.

SAFETY FEATURES MAKE FOR ROBUST OEM SYSTEMS

Remote control inputs and status monitor outputs streamline design and integration of OEM laser control systems, ensuring your system design is robust to real-world conditions and providing long-term reliability that you can trust. The latching current limit protects the laser diode by disabling the output when the current limit is reached, and the mechanical output shorting relay provides additional protection against conditions that might damage the laser diode. This driver is ideal for applications where current stability is critical and space is tight, such as benchtop inspection instruments and medical diagnostic equipment.

SPECIFICATIONS

PARAMETER	PLD5K	PLD10K	PLD12.5K	UNIT
Driver Supply Voltage	5 to 5.5			VDC
Laser Supply Voltage, High Compliance	4.5 to 30			VDC
Compliance Voltage	3 to 28			V
Max Output Current	5	10	12.5	A
Constant Current Short Term Stability, 1 hr	< 100	< 200	< 200	ppm
Constant Power Stability, 1 hr	< 0.02	< 0.05	< 0.05	%
Temperature Coefficient	< 200			ppm / °C
Modulation Bandwidth (CC, sinewave)	120	80	50	kHz
Rise / Fall Time	4.8 / 9.4	5.9 / 10	8 / 9	µsec



PLD10000/PLD12500 Series

FEATURES

Two models: 10 A and 12.5 A output current

PLD10000 can be operated from a 5 VDC supply

Separate power supply can be used to drive high-compliance lasers, up to 27.5 V

Constant Current or Constant Power modes

Safety features protect your laser

- Adjustable latching current limit
- Slow-start circuitry

Remote Enable controls

Optimized heatsink and fan simplifies integration

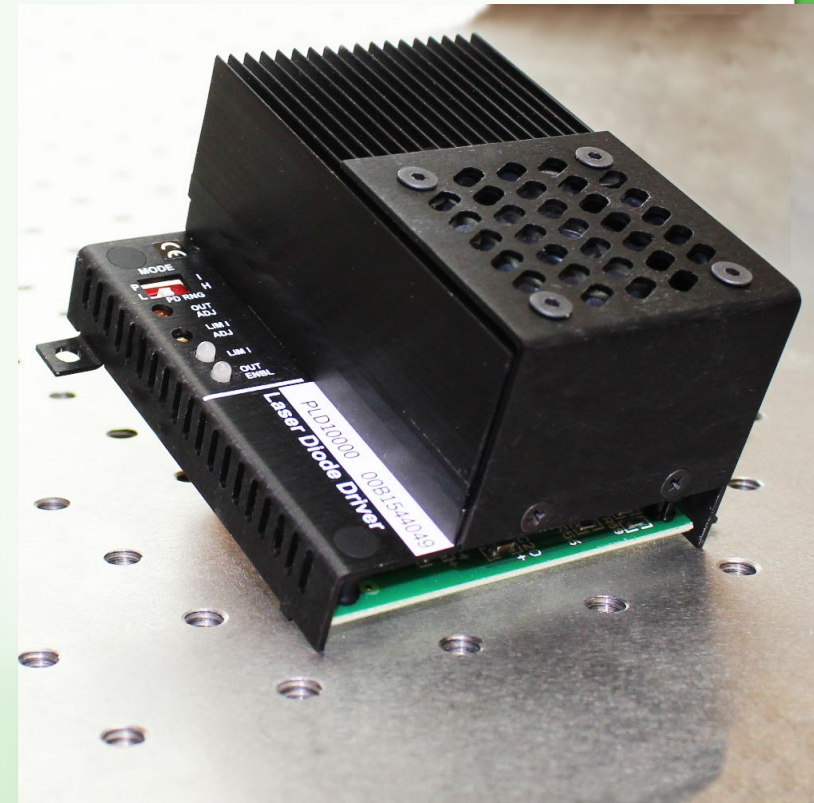

Size: 3.35 x 3.20 x 1.93 in (85.1 x 81.3 x 49.0 mm)

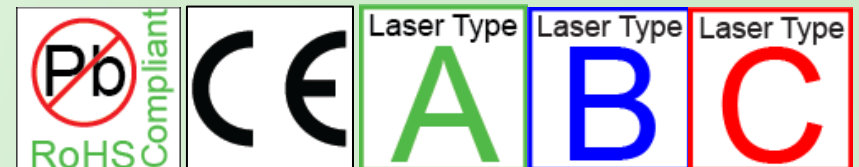

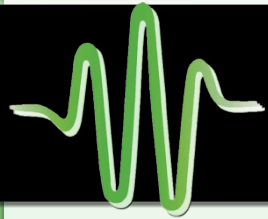

PLD10000/PLD12500 Series

RELIABILITY YOU CAN TRUST

The PLD Series Laser Diode Drivers deliver the reliability and performance you expect from a Wavelength Electronics laser driver in a compact and easy-to-integrate package. Tens of thousands of PLD drivers are deployed in laser systems around the world, proving beyond doubt the reliability and stability of the design.

PLD Series drivers are used for fiber laser pumping, materials processing, pyrotechnic ignition, industrial applications, and laser diode LIV testers.

DESIGNED FOR EASY INTEGRATION

The PLD10000 is powered by a 5 V supply, and the laser can be driven from the same supply. High-compliance lasers can be driven by using a separate supply up to 30 V. The PLD12500 requires two separate supplies.

LASER SAFETY FEATURES

Built-in safety features make your product more robust to real world operating conditions: latching current limit switches off the output if the current limit is reached; a slow start circuit ramps the output current; and a mechanical shorting relay protects the laser from ESD events while the output is switched off. Long-term reliability means better up-time, fewer service calls, and more customers who are satisfied with your products.

PLD DRIVER SPECIFICATIONS

DRIVER OUTPUT CURRENT	PLD10000	PLD12500	UNIT	NOTE
Max Output Current	10	12.5	A	
Short Term Stability, 1 hr	< 200	< 300	ppm	Constant Current mode
Short Term Stability, 1 hr	< 0.05	< 0.05	%	Constant Power mode
Compliance Voltage, Single Supply	2.5	—	V	+5 V and LD Anode tied at = 5 V
Compliance Voltage, Dual Supply	27.5		V	Power supply connected to LD Anode = 30 V
Temperature Coefficient	< 200		ppm / °C	
Photodiode Feedback Range, Low	15 – 500		µA	Type A/B lasers only
Photodiode Feedback Range, High	50 – 5000		µA	
EXTERNAL MODULATION				
Modulation Bandwidth, 3 dB	90	70	kHz	Constant Current mode
Depth of Modulation at 60 kHz	90		%	
Rise / Fall Time	7 / 8		µs	to full scale
POWER SUPPLY REQUIREMENTS				
Supply Voltage (+5 V)	5.0 – 5.5		VDC	+5 V and LD Anode tied
Supply Voltage (LD Anode)	3.0 – 30.0		VDC	Separate +5 V and LD Anode
Supply Voltage (Aux V+, Type-C Lasers)	8.0 – 12.5		VDC	Requires separate +5 V and LD Anode
Max Internal Power Dissipation	110	110	W	Refer to Safe Operating Area chart in product datasheet.
Quiescent Current	250	250	mA	

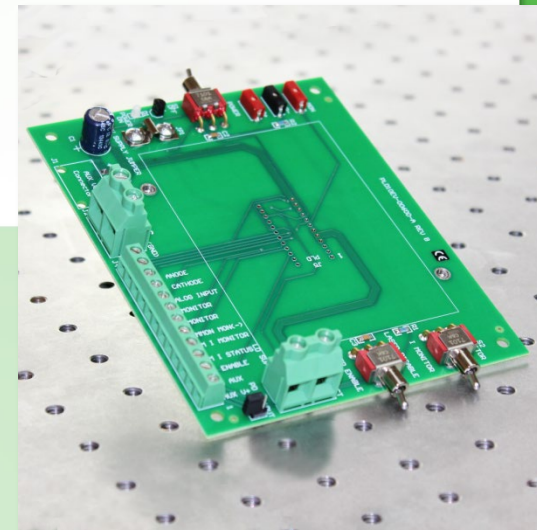

PLD10EV Evaluation Board



PLD PCB Series Laser Driver

FEATURES

- Models driving from 200 mA to 6.5 A
- Single 5 V power supply operation
- Compliance voltage up to 28 VDC with separate power supply
- Slow-start laser diode protection
- Constant Current or Constant Power mode
- Latching current limit
- Mechanical relay output protection
- Onboard or remote setpoint and limit controls
- Remote Enable / Disable input
- Integrated heatsink and fan



Size (PLD200/500): 1.5 x 2.7 x 0.8 in (39 x 67 x 21 mm)
(PLD1250/5000/6500): 1.5 x 2.7 x 1.8 in (39 x 67 x 45 mm)

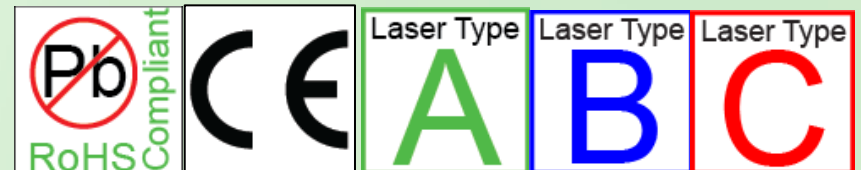



PLD PCB Series Laser Driver

RELIABILITY YOU CAN TRUST

The PLD Series Laser Diode Drivers deliver the reliability and performance you expect from a Wavelength Electronics laser driver in a compact and easy-to-integrate PCB-mountable package. Tens of thousands of PLD drivers are deployed in laser systems around the world, proving beyond doubt the reliability and stability of our most popular laser diode controllers.

Lasers with forward voltage drop up to 3 V can be driven using a single 5 V power supply. Lasers with a high compliance voltage—up to 28 V—can be accommodated by separating the electronics and laser power supplies.

PLD Series drivers are found in particle counters, manufacturing vision systems, photovoltaic quantum efficiency testers, wavefront scanners, fiber aligners, and laser diode LIV testers.

DESIGNED FOR EASY INTEGRATION

Onboard controls simplify prototyping and benchtop use, especially when used with the PLDEVAL evaluation circuit board. Remote control inputs and external monitors allow the PLD controllers to be integrated into an automated control system, ensuring your system design is robust to real-world operating conditions. The latching current limit protects the laser diode by disabling the output when the current limit is reached, and the mechanical output shorting relay provides additional protection against potentially damaging ESD events.

SPECIFICATIONS

PARAMETER	PLD200	PLD500	PLD1250	PLD5000	PLD6500	UNIT
Driver Supply Voltage	5 to 5.5					VDC
Laser Supply Voltage, High Comp.	3 to 30					VDC
Compliance Voltage	3 to 28					V
Max Output Current	0.2	0.5	1.25	5.0	6.5	A
Constant Current Short Term Stability, 1hr	< 100	< 100	< 100	< 200	< 200	ppm
Constant Power Stability, 1 hr	0.02					%
Temperature Coefficient	< 200					ppm / °C
Modulation Bandwidth (CC, sinewave)	190	200	200	150	100	kHz
Rise / Fall Time	3 / 5	3 / 5	3 / 5	3 / 12	5 / 12	µsec

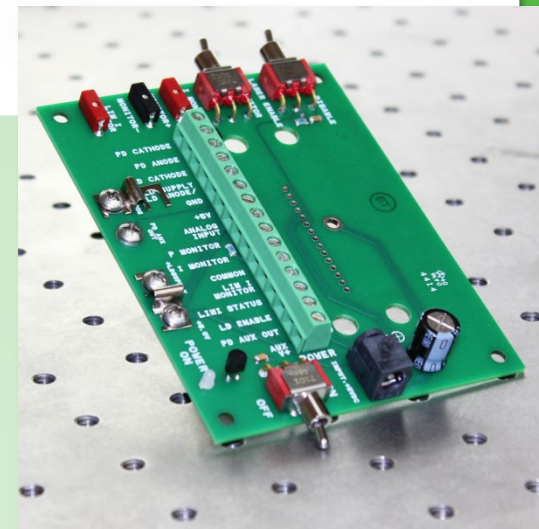



WLD33ND Series Drivers & Board

FEATURES

- Up to 3 A Output Current
- Slow-start laser diode protection
- TTL-compatible shutdown pin
- Adjustable current limit and current range
- Over-temperature shutdown
- 14-Pin DIP PCB Mount
- Constant Current or Constant Power mode
- Voltage controlled setpoint
- 2 MHz Bandwidth (CC, sinewave)

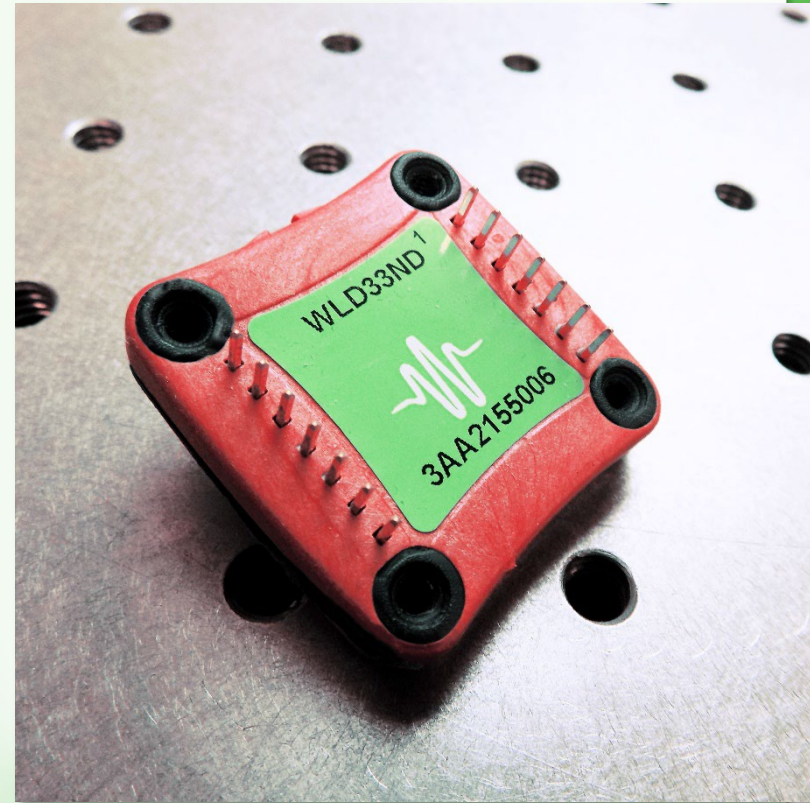

Size (WLD33ND): 1.3 x 1.3 x 0.3 in (33 x 33 x 8 mm)
(with heatsink): 1.3 x 1.3 x 0.87 in (33 x 33 x 22 mm)
(with heatsink & fan): 1.3 x 1.3 x 1.3 in (33 x 33 x 33 mm)

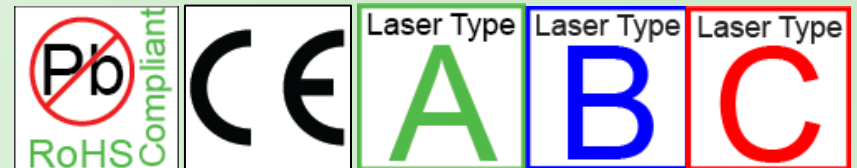

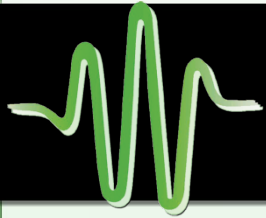

WLD33ND Series Drivers & Board

COMPACT LASER DIODE DRIVER

The WLD33ND is a compact DIP-packaged laser diode driver that operates in Constant Current or Constant Power mode, and can be modulated up to 2 MHz. No leakage current makes it ideal for low current VCSELs.

A number of safety features are built-in to protect the laser: adjustable current control range and limit, slow-start, and a TTL-compatible shutdown pin. The over-temperature protection circuit safely switches off the laser if the driver reaches an unsafe operating temperature.

When driving up to 500 mA the WLD33ND does not need a heatsink—the slim metal-backed case is sufficient for self-cooling. For higher current requirements the heatsink and fan are available.

Minimal external electronics are required to operate the WLD33ND. An online circuit calculator speeds selection of component values. The WLD33ND-2AEV and WLD33ND-3AEV evaluation boards make setup and configuration even easier.

APPLICATIONS

This laser diode driver is ideal for applications where space is tight. It is widely used in electro-optic instrumentation, spectrometers, medical diagnostic equipment, range finders, and on research benches.

SPECIFICATIONS

PARAMETER	MIN	TYP	MAX	UNIT
Driver Supply Voltage		4.5 to 12		VDC
Compliance Voltage	3.0		10	V
Max Output Current		2.2	3	A
CC Stability, 1 hr		200		ppm
CP Stability, 1 hr		0.01		%
Constant Current Bandwidth (sinewave)		2		MHz
Rise / Fall Time		460 / 320		nsec
Leakage Current		0		mA

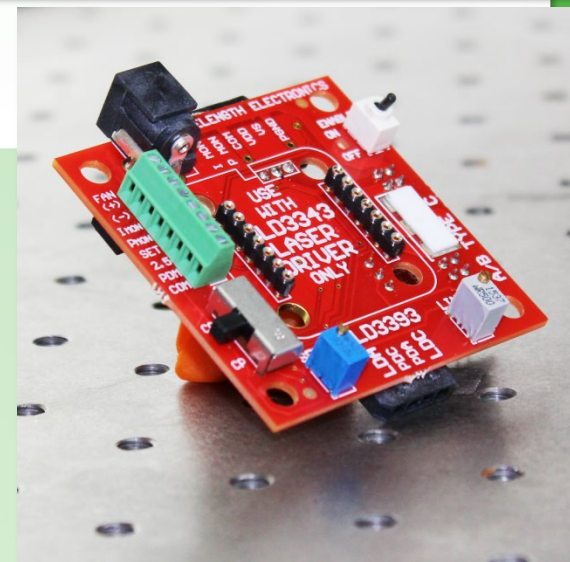



FL500 SMT Laser Diode Driver

FEATURES

Low Cost

Two 250 mA outputs or one 500 mA output

Single Supply Operation: 3 to 12 V

12-pin SMT package, reflow compatible

Laser slow start, brownout protection

Voltage controlled setpoint

TTL-Compatible shutdown pin

Multiple FL500s can be paralleled to provide higher drive current

FL591FL Evaluation Board available

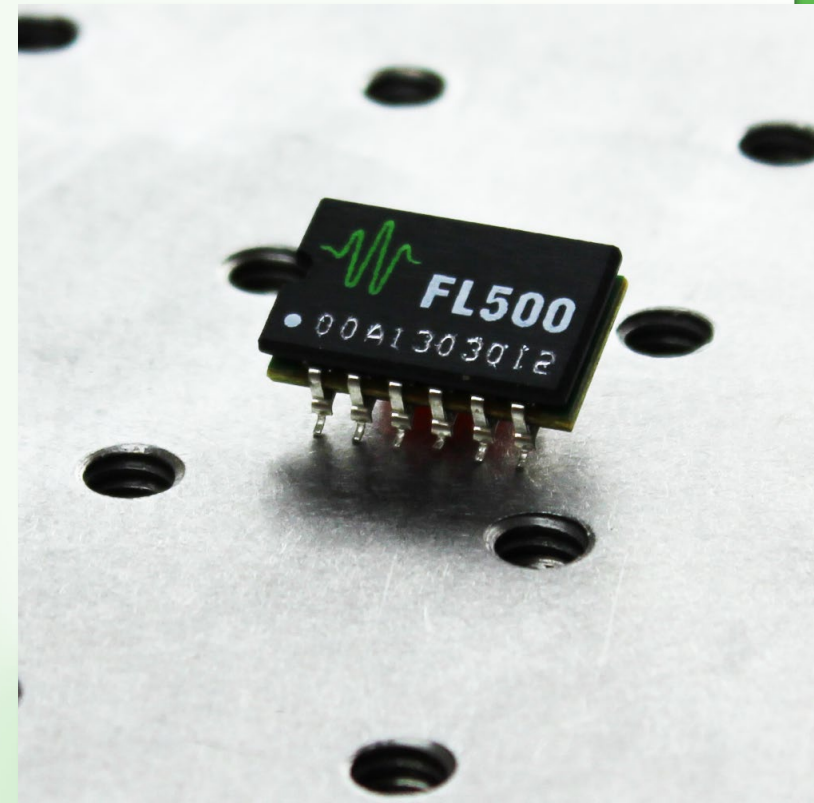

Size (FL500): 0.75 x 0.45 x 0.26 in (19 x 12 x 7 mm)

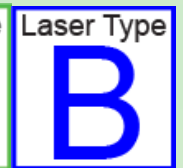
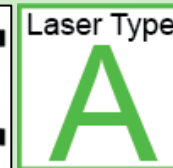

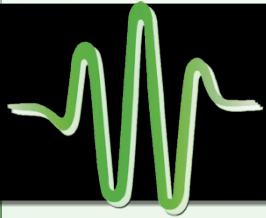

FL500 SMT Laser Diode Driver

SMT LASER CONTROL MADE EASY

The FL500 is ideal for driving laser diodes when you are designing your own electronics control system to suit exactly your application requirements. The FL500 is nearly a drop-in laser driver and requires very little external circuitry.

The wide supply voltage range—from 3 to 12 VDC—allows it to be operated from portable Li+ battery power systems.

REMARKABLY EASY TO INTEGRATE

The FL500 can be configured as two independent 250 mA drivers or a single 500 mA driver. The only external components required are a power supply, an analog voltage signal to control the output setpoint, and the laser. Additional output filters can be added to reduce noise further.

EASY TO PROTOTYPE

The FL591FL evaluation board allows you to configure the FL500 in minutes. The FL591FL features low-noise electronics and low quiescent current, and the feedback and monitor signals allow you to accurately characterize the included FL500. It also allows the FL500 to be configured to operate in Constant Power or Constant Current mode.

APPLICATIONS

Because of its compact size and light weight the FL500 is commonly used in hand-held, portable, space-constrained, and airborne applications. The dual-channel output is ideal for sighting-and-detection applications.

SPECIFICATIONS

PARAMETER	MIN	TYP	MAX	UNIT
Driver Supply Voltage	3 to 12			VDC
Compliance Voltage	$V_{DD} - (0.5 * V_{SET})$			V
Output Current	(2x) 250 or (1x) 500			mA
Constant Current Stability, 1 hr		35	40	ppm
Constant Current Bandwidth (sinewave)	500			kHz
Rise / Fall Time	300 / 300			nsec
Leakage Current	0.3 - 1			mA

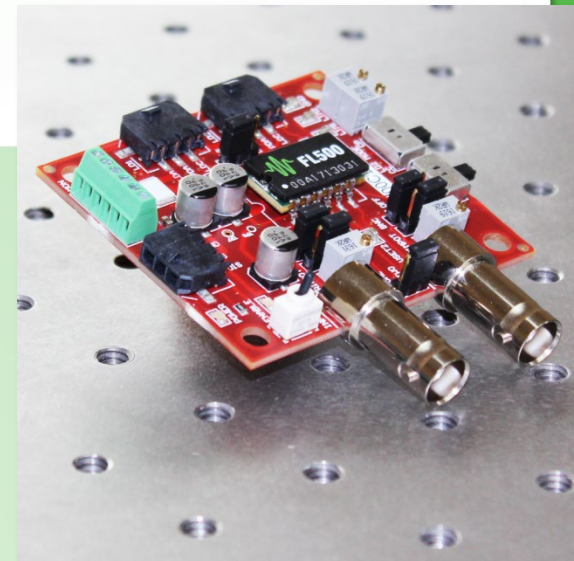



LDD P Series Laser Diode Driver

FEATURES

- Low Noise — Up to 400 mA drive current
- Single Supply Operation: 5 to 12 V
- Onboard control trimpots
- 8-Pin DIP Package
- Slow Start & Current Limit protection
- Constant Current operation
- 2 MHz Bandwidth (CC, sinewave)
- Buffered measurement outputs

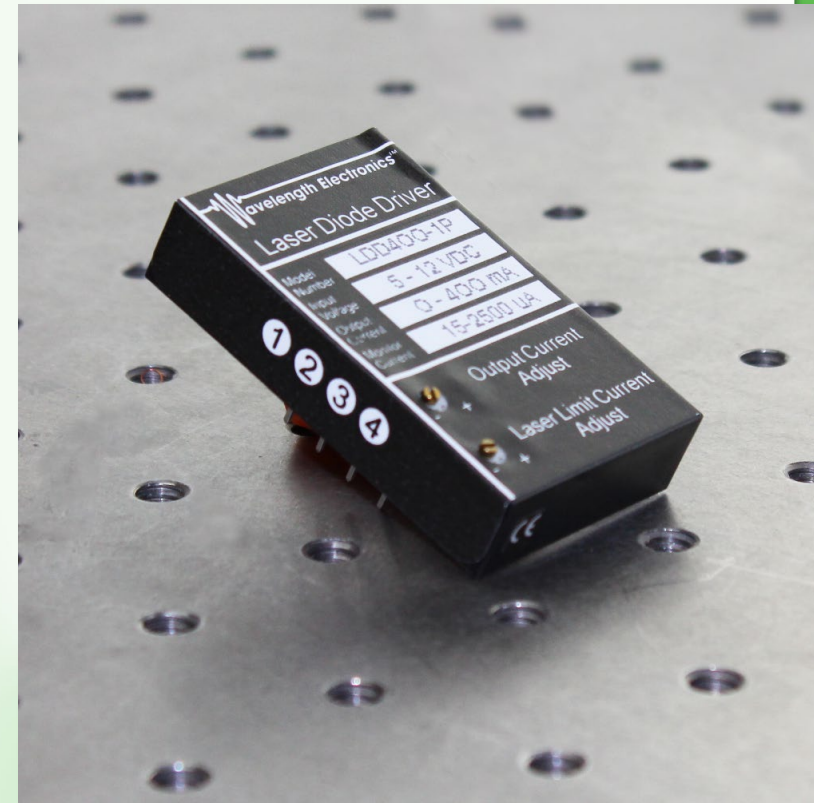

Size: 1.3 x 2.1 x 0.4 in (33 x 52 x 11 mm)

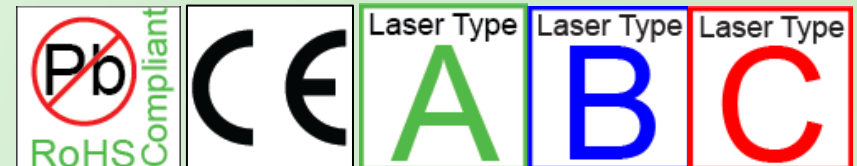



LDD P Series Laser Diode Driver

LOW NOISE, HIGH STABILITY

When it is essential to have high performance in your application, these low noise drivers offer excellent current stability in Constant Current mode.

Precisely control the laser diode setpoint current with the onboard output current adjustment trimpot or via a remote voltage to the modulation input. Adjust the limit current trimpot to protect the laser diode from exceeding its maximum current rating even when modulating your laser diode. Measure laser diode current from a buffered monitor output.

An evaluation board (LDDEVALP) and cable are available to speed implementation of the LDD in your application.

Very low leakage current (15 μA) makes the LDD ideal for driving most VCSELs using the remote modulation setpoint input. It operates from +5 to +12 V. Just add an external power supply and your laser diode to this simple 8-pin driver.

The LDD Series is excellent for laser spectroscopy, electro-optical systems, and contamination control devices.

SPECIFICATIONS

PARAMETER	LDD200	LDD400	UNIT
Driver Supply Voltage	5 to 12		VDC
Max Output Current	200	400	mA
Noise (RMS)	< 5		μA
Current Stability, 24 hr	< 50		ppm
Temperature Coefficient	< 100		ppm / $^{\circ}\text{C}$
CC Bandwidth (sinewave)	2		MHz
Rise / Fall Time	120 / 120		nsec
Leakage Current	< 15		μA

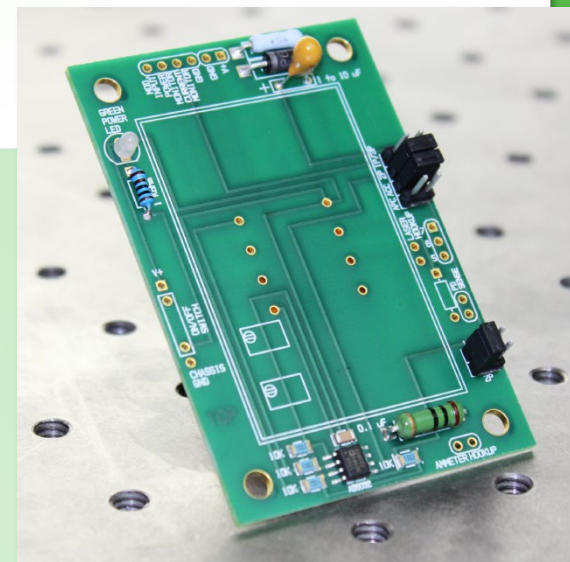



LDTC Series Integrated Driver

FEATURES

Laser Current: 500 mA, 1 A, or 2.2 A

Temperature Control up to 2.2 A

Single supply operation or separate supplies

Laser driver 3 to 12 VDC

Temperature controller 5 to 30 VDC

Laser diode driver features

Slow start protection

Constant Current or Constant Power mode

Adjustable laser diode current limit

Remote TTL shutdown / interlock

Failsafe setpoint default for temperature setpoint

All cables included



Size (LDTCxx20): 2.4 x 2.9 x 1.1 in (60 x 74 x 28 mm)
(LDTC 2/2 E): 4.8 x 2.7 x 1.14 in (122 x 69 x 29 mm)
(LDTC 2/2 O): 4.2 x 2.5 x 1.0 in (107 x 64 x 25 mm)

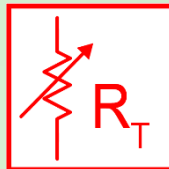
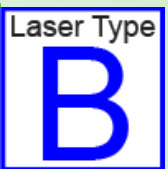

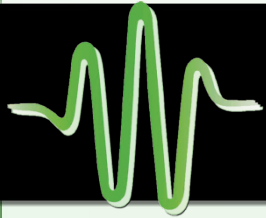

LDTc Series Integrated Driver

INTEGRATED CONTROL MADE SIMPLE

These combination controllers integrate the FL500 or WLD3343 Laser Diode Driver with the ultra-stable WTC3243 Temperature Controller.

We make these modules easy to use by providing onboard controls for every key parameter needed for complete laser diode and temperature control. The control parameters are also accessible via connectors so you can easily integrate the module into your OEM laser system.

STABLE AND RELIABLE

The LDTc_{xx}20 includes one or two FL500s to drive up to 1 A to the laser diode. The LDTc 2/2 includes the WLD laser driver with up to 2.2 A drive current.

All models include the ultra-stable WTC3243 that provides up to 2.2 A of bipolar current for operating a thermoelectric cooler, or unipolar current for a resistive heater.

CRITICAL SAFETY FEATURES

Important safety features protect the laser and TEC, and make the entire laser control system more robust to real-world operating conditions: adjustable current limits, slow-start and brown-out protection, and a special failsafe feature that drives the TEC to a safe temperature if the external temperature setpoint signal is lost.

SPECIFICATIONS

PARAMETER	LDTc 0520	LDTc 1020	LDTc 2/2	UNIT
Laser Driver Supply Voltage	3 to 12		5 to 12	VDC
Compliance Voltage, LD	$V_{DD-FL} - (0.5 \times V_{SET})$		5-10	V
Laser Output Current	0.5	1	2.2	A
Constant Current Stability, 1 hr	35-40		50-75	ppm
Constant Power Stability, 1 hr	0.019		0.01	%
Modulation Bandwidth (CC, sinewave)	0.5		1.6	MHz
Rise / Fall Time	300 / 300		460 / 320	nsec
Leakage Current (Laser Control)	0.3	1	0	mA
Temp Controller Power Supply	5 to 12			VDC
Output Power Supply	5 to 30		5 to 28	VDC
Compliance Voltage, TC	$V_s - 0.5$			V
Temperature Controller Output Current	± 2.2			A
Temperature Stability, 1 hr (10 k Ω thermistor @ 25°C)	0.002			°C



PTC-CH Series Temp Controller

FEATURES

Drive ± 2.5 A, ± 5 A or ± 10 A current

Single Supply Operation from 5 to 30 VDC

Linear Stability: 0.0012°C

Onboard and remote controllable

- Remote or onboard temperature setpoint control

- Remote or onboard enable / disable

- Adjustable current limit

“Smart Integrator” quickly settles to temperature even on large thermal loads

Selectable sensor bias current

Failsafe setpoint default circuit

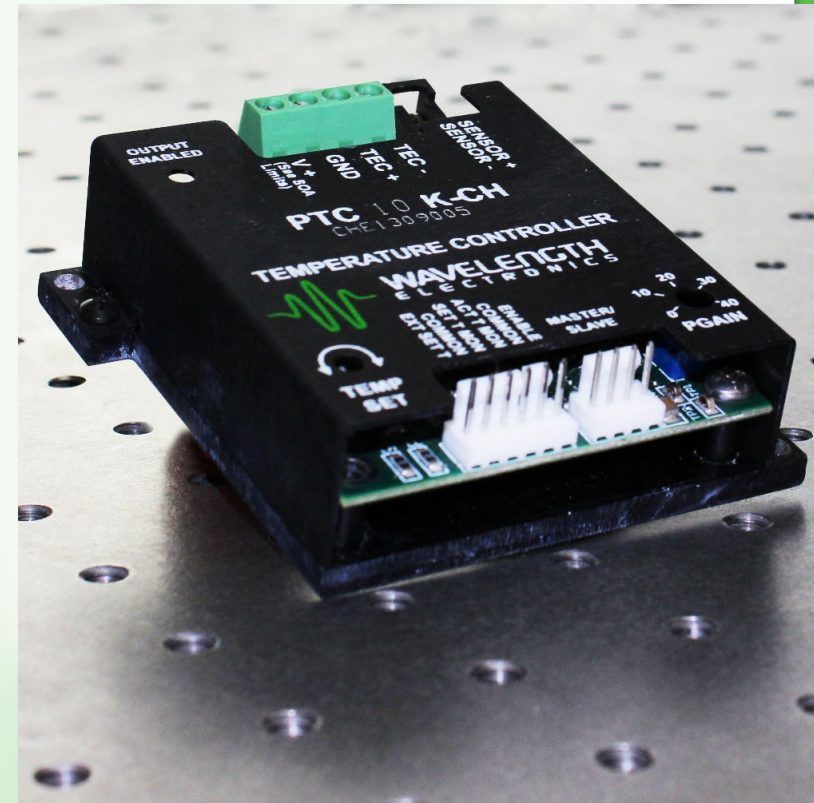

Size: 3 x 3 x 1.1 in (76 x 76 x 28 mm)





PTC-CH Series Temp Controller

STABLE EVEN ACROSS AMBIENT

The PTC-CH Series Precision Temperature Controllers are compact, chassis-mount modules that provide excellent temperature stability—even across ambient. The linear bipolar output drives TECs, and it can be easily configured for unipolar heater operation. PTC-CH controllers are found in such diverse applications as particle and droplet measurement, manufacturing machine vision systems, biomolecular interaction analysis, and more.

FLEXIBLE AND EASY TO USE

The PTC-CH controllers are designed to be integrated into your laser control system. With onboard trimpots for current limit, temperature setpoint, and proportional gain, it's also easy to use the controller on your benchtop, too.

An LED indicates when output current is enabled. An external voltage can be used for remote setpoint operation, and if the setpoint signal is lost the controller automatically reverts to a “safe” temperature setpoint.

PRACTICAL FEATURES FOR REAL-WORLD CONDITIONS

- The PTC10K-CH can be linked with the PTC10K-SL to increase the output current up to 20 A.
- Sensor bias currents can be configured to maximize feedback sensitivity with a variety of sensors.
- Low temperature coefficient design remains stable across a wide range of ambient conditions.
- Remote limit capability allows a DAC to set the current limit.

SPECIFICATIONS

PARAMETER	PTC2.5K	PTC5K	PTC10K	UNIT
Controller Supply Voltage	4.5 to 30			VDC
Compliance Voltage	$V_{DD} - 1.5$	$V_{DD} - 2.2$	$V_{DD} - 4.5$	VDC
Max Output Current	± 2.5	± 5	± 10	A
Temperature Stability, 1 hr (10 k Ω thermistor @ 25°C)	< 0.0012			°C
Temperature Coefficient	< 100			ppm / °C



PTC PCB Series Temp Controller

FEATURES

- Drive ± 5 or ± 10 A of TEC or heater current
- Single supply operation: 5 to 30 VDC
- Remote Output Enable
- Remote Temperature Setpoint
- Short term stability of 0.0012°C (off-ambient)
- Long term stability 0.002°C
- Selectable sensor bias current
- Adjustable current limit
- PI Control with "Smart Integrator"
- Failsafe Setpoint default in case of remote temperature setpoint signal error

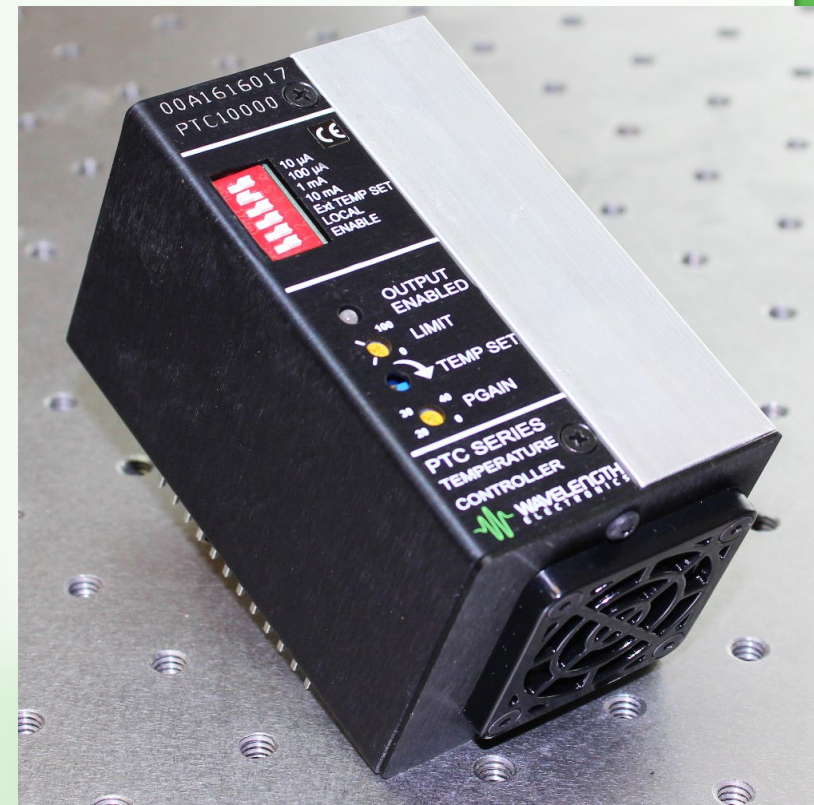

Size: 2.32 x 2.15 x 3.85 in (97.7 x 54.7 x 58.9 mm)



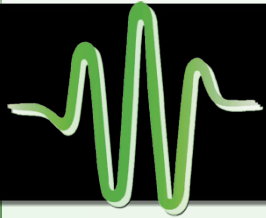

PTC PCB Series Temp Controller

TIME-TESTED RELIABILITY

The PTC Series PCB-Mount Temperature Controllers are based on our long-proven PTC-CH controllers, and deliver the same stable performance and long-term reliability.

PTC Series controllers are found in such diverse applications as particle and droplet measurement, communication systems, manufacturing test systems, and more.

POWERFUL AND EASY TO USE

The PTC controllers operate from a single power supply between 5 V and 30 V, and two models drive ± 5 A or ± 10 A to a Peltier thermoelectric cooler or a resistive heater. These controllers mount directly to your circuit board.

PTC controllers interface with a variety of temperature sensors, and the bias current is adjustable in order to maximize controller sensitivity and stability for your application.

You can use the PTCEVAL board to quickly configure the PTC controller for prototyping. Using the same controller for development and production helps guarantee there are no surprises when it's time to release the final design.

PTC-PCB CONTROLLER SPECIFICATIONS

CONTROLLER OUTPUT CURRENT	PTC5000	PTC10000	UNIT	NOTE
Max Output Current	± 5.0	± 10.0	A	
Short Term Stability, 1 hr	< 0.0012		$^{\circ}\text{C}$	Off-ambient, 10 k Ω thermistor at 25 $^{\circ}\text{C}$
Short Term Stability, 1 hr	< 0.0014		$^{\circ}\text{C}$	On-ambient, 10 k Ω thermistor at 25 $^{\circ}\text{C}$
Long Term Stability, 24 hr	< 0.002		$^{\circ}\text{C}$	Off-ambient, 10 k Ω thermistor at 25 $^{\circ}\text{C}$
Temperature Coefficient	< 100		ppm / $^{\circ}\text{C}$	
Compliance Voltage	$V_S - 1.7$	$V_S - 3$	V	$V_S > 5.3$ VDC
External Setpoint Range (V_{EXT})	0 to 5		V	
TEMPERATURE SENSORS	PTC5000	PTC10000	UNIT	NOTE
Sensor Compatibility	Thermistor, Linear, RTD			
Sensor Bias Current Range	0.01, 0.1, 1, 10		mA	
Sensor Voltage Range	0 to ($V_S - 1.5$) 0 to 5.5		V	$V_S < 7$ VDC $V_S = 7$ to 30 VDC
Setpoint vs. Actual Accuracy	1		mV	
POWER SUPPLY REQUIREMENTS	PTC5000	PTC10000	UNIT	NOTE
Controller Supply Voltage (V_S)	5 to 30		VDC	
Quiescent Current	220		mA	
Maximum Internal Power Dissipation	110		W	

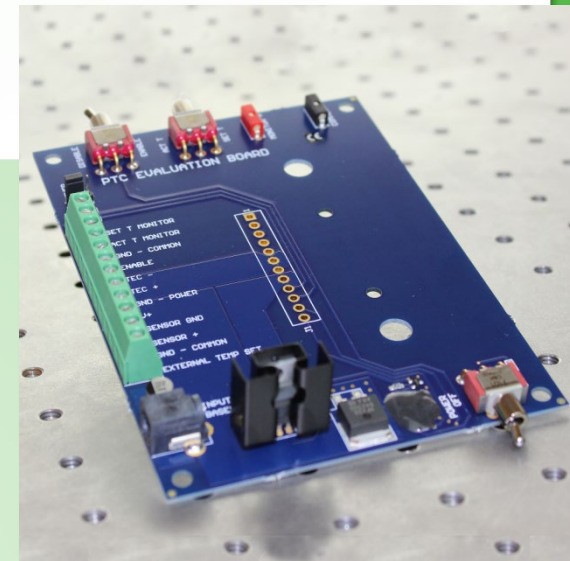



LFI3751 Temp Control Instrument

FEATURES

PID Autotune quickly optimizes Temperature Controller for any thermoelectric load.

24-hour Temperature Stability: 0.003°C

Max Thermoelectric Current Output: ± 5 Amps

Proportional Gain Range: 1 to 100

Integrator Time Constant Range: 1 to 10 seconds

Differential Time Constant Range: 1 to 100 seconds

Supply Voltage: +115 VAC to +230 VAC

Addressable RS-232 Interface

Digital PID Improves Stability with RTDs by as much as a factor of five

Digital PID Improves Overshoot Suppression

50% Faster Settling Times with Digital PID



Size: 4.25 x 12 x 6.5 in. (108 x 305 x 165 mm)

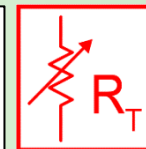



LFI3751 Temp Control Instrument

TEMPERATURE CONTROL WITH AUTOTUNE

The LFI3751 with Autotune PID is a high-performance temperature control instrument. Drive up to ± 5 A to either thermoelectrics (TECs) or resistive heaters (RH) with up to 8 V compliance. This instrument operates from AC (115 / 230, 50 or 60Hz). Expect stability as good as 0.001°C with thermistors. Even across ambient, this PID controller maintains precision temperature.

From the front panel, adjust temperature limits, current limits, setpoint, PID control values, sensor calibration data, and enable or disable output current. The 4-digit display shows actual or setpoint temperature or resistance, output current and voltage.

Sensor calibration is easy with a reference right on the front panel. Also, view Thermoelectric current and voltage and limit current settings.

UNIQUE FEATURES

Autotune PID is a sophisticated algorithm for optimizing the PID control parameters to your load. With the touch of a button, the LFI3751 automatically optimises control settings for most thermal loads, reducing overshoot or improving temperature stability.

Autoranging sensor bias currents keep your sensor voltage in the optimal range for maximum signal to noise ratio.

Addressable RS232 and **USB** control is available. **Benchlink** software simulates the front panel control from your PC. **LabVIEW** drivers simplify computer control.

The LFI3751 Digital option provides better setpoint resolution and stability with low-resolution sensors such as RTDs. This option also offers improved overshoot suppression, 50% faster settling times, and faster calibration.

SPECIFICATIONS

PARAMETER	TYPICAL
Power Supply Voltage	115 / 230 VAC 60 / 50 Hz
Max Output Current	± 5 A
Temperature Stability, 1 hr (10 k Ω thermistor @ 5°C)	0.001°C
Temperature Stability across ambient (10 k Ω thermistor @ 5°C)	0.001°C
Setpoint Resolution	12 bit D to A



RHM5K-CH Unipolar Temp Control

FEATURES

- Compact, 5 A unipolar drive current
- Single supply operation 5 to 30 VDC
- > 27 V compliance with 30 V input
- < 0.002°C stability
- Adjustable output voltage limit
- Supports thermistors, IC sensors, or RTDs
- PID control
- Temperature setpoint, proportional gain, and limit voltage are user adjustable
- Easy operation for resistive heater or TECs

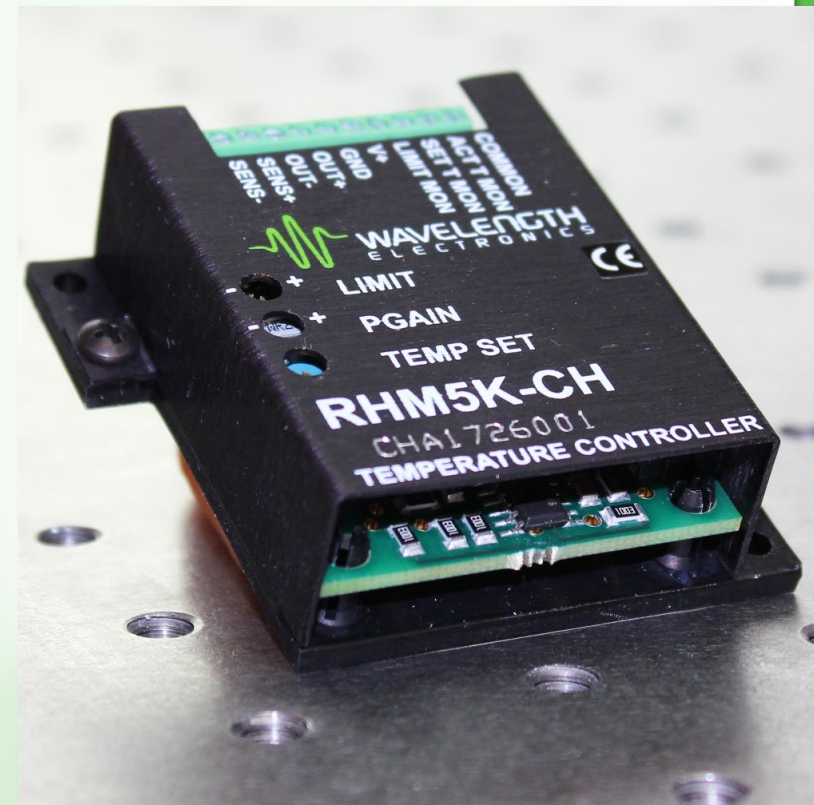

Size: 2.1 x 2.1 x 0.8 in (55 x 55 x 20 mm)





RHM5K-CH Unipolar Temp Control

PRECISION UNIPOLAR TEMPERATURE CONTROLLER

The RHM5K-CH Temperature Controller is for applications that require a unidirectional current to either heat or cool a load at off-ambient temperatures. The RHM is very compact, drives up to 5 A, and controls with a high degree of stability.

PLUG-AND-PLAY

Nearly any kind of temperature sensor can be used with the RHM controller, and onboard 12-turn trimpots control temperature setpoint, proportional gain, and output voltage limit.

A 10-pin terminal strip provides easy access to the DC supply, sensor, heater or TEC, and monitor connections. The minimal number of external connections means you can configure and run the RHM in a matter of minutes.

WIDE RANGE OF APPLICATIONS

The RHM5K-CH is suited for applications where either heating or cooling—but not both—is required.

Made for applications where temperature stability is critical and space is tight, such as heated optics (non-condensing), CCDs, preheated liquids and chamber stabilization.

SPECIFICATIONS

PARAMETER	MIN	TYP	MAX	UNIT
Power Supply Voltage		4.5 to 30		VDC
Compliance Voltage	V - 3		V - 2.5	V
Max Output Current		5		A
Temperature Stability, 1 hr (10 kΩ thermistor @ 17°C)	0.0005		0.002	°C
Temperature Coefficient		20		ppm / °C



WTCP PWM Temperature Controller

FEATURES

- Drive up to ± 5 A at 5 V to TEC
- Compatible with Thermistors
- High Efficiency Pulse-Width Modulated controller
- PCB-mounted 22-pin module
- Single 5 VDC supply operation
- Short term stability 0.001°C
- Adjustable voltage and current limits
- Highly functional and easy-to-use evaluation board simplifies prototyping and saves money

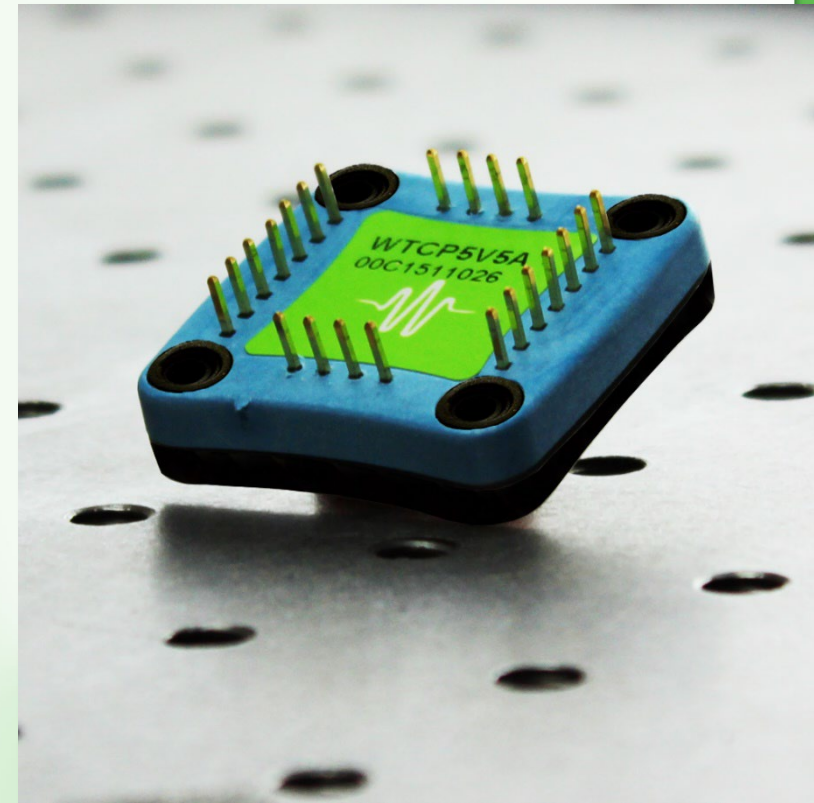

Size: 1.3 x 1.3 x 0.3 in (33 x 33 x 8 mm)



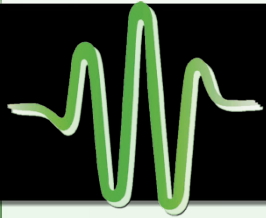

WTCP PWM Temperature Controller

COMPACT, POWERFUL, AND EFFICIENT

The WTCP5V5A Temperature Controller delivers all the advantages of Pulse Width Modulated (PWM) control in a PCB-mounted package. Compact and efficient, the WTCP usually does not require any additional heatsinking, even when operated at full output current.

The temperature operating range of the WTCP can be fine-tuned to maximize stability around the operating point, and built-in safety features help make your system robust to real-world operational conditions.

A feature-packed evaluation board lets you explore the WTCP, and streamlines your system characterization. We also offer an OEM system board that is customized at the factory with the discrete component values you specify, and is easily integrated into your product.

The WTCPOEM board condenses the adjustable functions of the WTCPEVAL board into a compact, fixed-value board, perfect for system integration. At 2.1" x 2.0", it includes a monitor/output connector, either a setpoint trimpot for a variable setpoint or a resistor pair for a fixed setpoint, resistors to set cooling and heating limits, and all the tuning parameters.

APPLICATIONS

The WTCP is perfectly suited for applications requiring high efficiency, low power dissipation, and high stability. Portable, airborne, and space-constrained temperature control applications benefit from the performance boost delivered by the WTCP5V5A.

SPECIFICATIONS

PARAMETER	MIN	TYP	MAX	UNIT
Power Supply Voltage		4.5 to 5.5		VDC
Compliance Voltage		$V_{DD_P} - 0.35$		V
Max Output Current		± 5		A
Temperature Stability, 1 hr (10 k Ω thermistor @ 25°C)		< 0.001		°C
Temperature Coefficient		< 200		ppm / °C
Efficiency	83		95	%

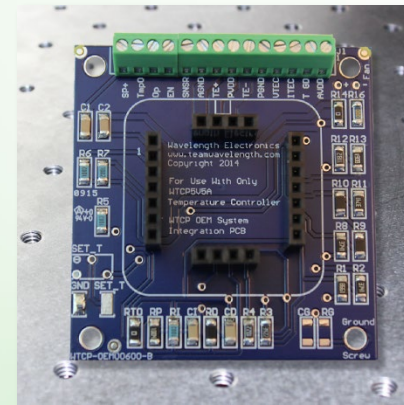

WTCP-OEM Board

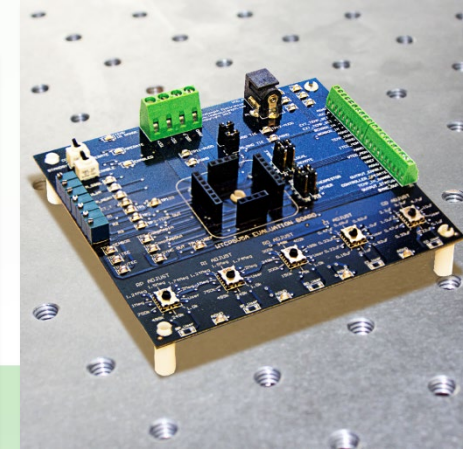

WTCPEVAL Board



HTC Series Temperature Controller

FEATURES

- Drive ± 1.5 A, ± 3 A, or ± 4 A to a TEC or heater
- Single Supply Operation 5 to 30 VDC
- Ultra-stable PI Control
- Linear Stability: 0.0009°C
- Heat and cool current limits
- 20-pin SIP PCB mount
- Adjustable sensor bias current
- Monitor Actual and Setpoint Temperature
- Supports thermistors, RTDs, and IC sensors



Size: 3.2 x 2.8 x 1.2 in



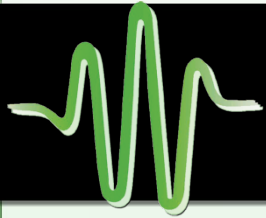

HTC Series Temperature Controller

LOW PROFILE

The advanced and reliable circuitry of the HTC Series achieves 0.0009°C temperature stability. The slim profile package is ideal for designs with space constraints, and can either be circuit board-mounted or fixed to a chassis heatsink and connected via cable.

External discrete components are used to set the limit current, proportional gain, integrator time constant, and sensor bias current. The output current can be controlled by adding a trimpot, or by a voltage signal on the analog input pin. Setpoint and actual temperature can be monitored with a digital voltmeter via buffered monitor outputs.

The HTCEVALPCB evaluation board simplifies prototyping, and can be integrated directly into some OEM applications. Wavelength also provides a direct-mount heatsink sized for the HTC controllers.

The HTC can be operated with up to 30 VDC power supply voltage; contact the factory for information on simple product variations.

The HTC has proven reliable in such diverse fields as medical, defense, communications and manufacturing.

SPECIFICATIONS

PARAMETER	HTC1500	HTC3000	HTC4000	UNIT
Power Supply Voltage (V_+)	5 to 30			VDC
Compliance Voltage	(V - 1.33) to (V - 0.13) depending on output current			V
Max Output Current	± 1.5	± 3	± 4	A
Temperature Stability, 1 hr, (10 kΩ thermistor @ 25°C)	0.0009			°C

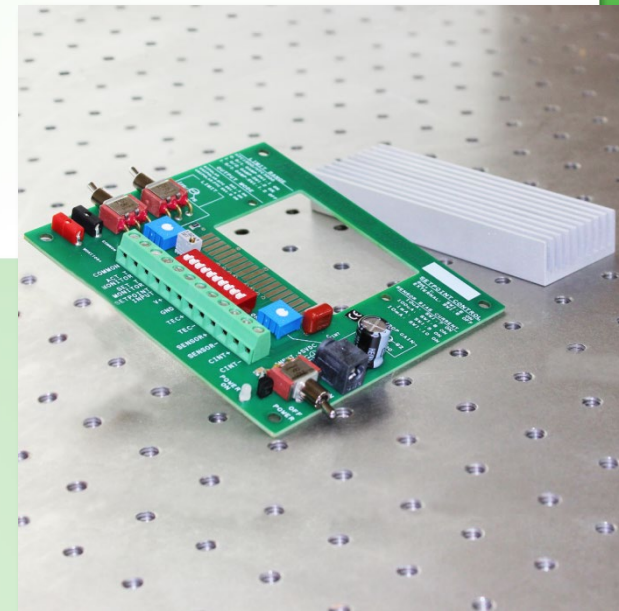



WTC Series Temperature Control

FEATURES

- Drive ± 2.2 A TEC or RH Current
- Single supply operation: 5 to 30 V
- Ultra-stable PI control
- Stability of 0.0009°C
- Separate heat and cool current limits
- Supports thermistors, RTDs, and IC sensors
- Adjustable sensor bias current
- 14-pin DIP PCB mount
- Monitor actual temperature sensor voltage

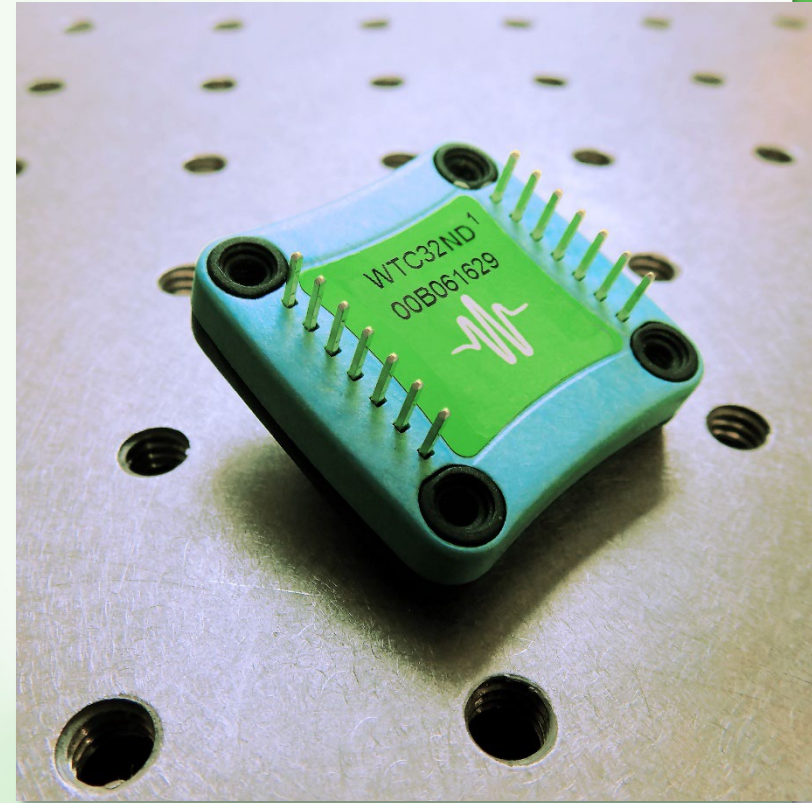

Size (WTC32ND): 1.3 x 1.3 x 0.3 in (33 x 33 x 8 mm)
(with heatsink): 1.3 x 1.3 x 0.87 in (33 x 33 x 22 mm)
(with heatsink & fan): 1.3 x 1.3 x 1.3 in (33 x 33 x 33 mm)





WTC Series Temperature Control

STABLE, COMPACT, VERSATILE

The ultrastable and compact WTC32ND Temperature Controller is particularly suited to applications where temperature is scanned across ambient. The award-winning package can drive up to 500 mA with no additional heatsinking, and it will drive up to 2.2 A with our specially-designed heatsink and fan combination. The WTC32ND-HB operates on 3.6 V Lithium-ion batteries, and integrates perfectly with the WLD33ND-HB laser driver for portable use.

EASY TO USE

The WTC32ND is easily configured for virtually any type of temperature sensor and the built-in sensor bias current source simplifies use with resistive temperature sensors. The proportional gain and integrator time constant are set by external resistors and can be modified to minimize temperature overshoot and maximize stability. Our online circuit calculator tool speeds selection of external components.

WTC32ND-EV EVALUATION BOARD

Use the WTC32ND-EV Evaluation Board to simplify operation of the WTC32ND Temperature Controller. Onboard switches, connectors, and trimpots provide fast, simple local control and the screw terminal connectors also allow for remote operation.

SPECIFICATIONS

PARAMETER	MIN	TYP	MAX	UNIT
Controller Supply Voltage		4.5 to 30		VDC
Load Supply Voltage		3 to 30		VDC
Compliance Voltage	$V_s - 0.6$		$V_s - 0.1$	V
Max Output Current		± 2.2		A
Temperature Stability, 1 hr, (10 k Ω thermistor @ 25°C)		0.0009		°C

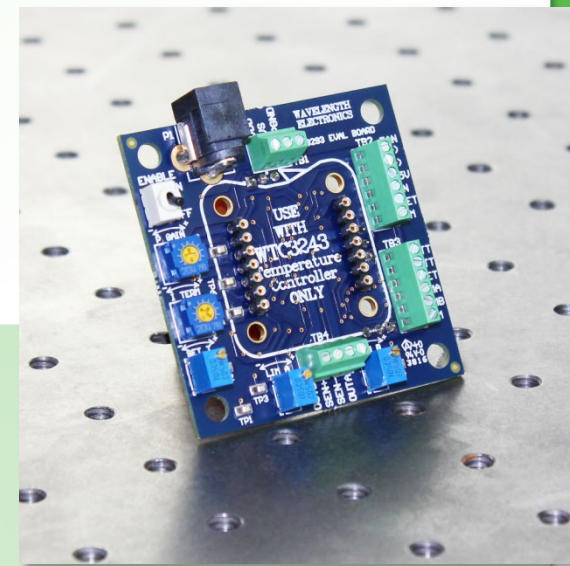



WHY56ND Temperature Controller

FEATURES

- Low Cost
- Master / Booster multiple units for more current
- Drive up to ± 2.2 A load current
- Single supply operation: 5 to 26 VDC
- Linear PI control
- Heat and cool current limits
- 14-pin DIP PCB mount

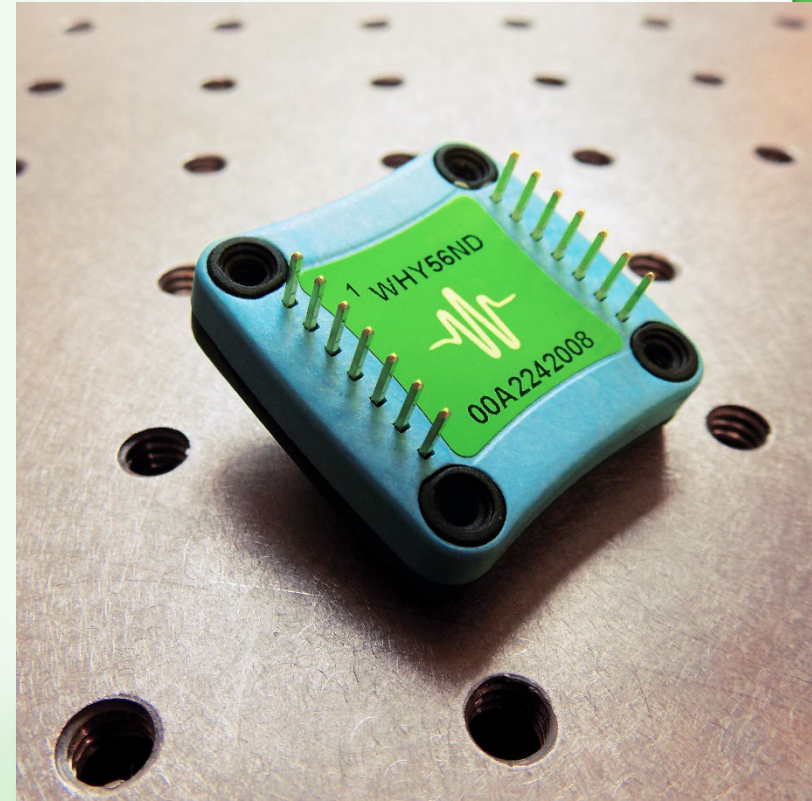

Size (WHY56ND): 1.3 x 1.3 x 0.3 in (33 x 33 x 8 mm)
(with heatsink): 1.3 x 1.3 x 0.87 in (33 x 33 x 22 mm)
(with heatsink & fan): 1.3 x 1.3 x 1.3 in (33 x 33 x 33 mm)

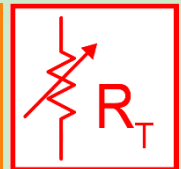

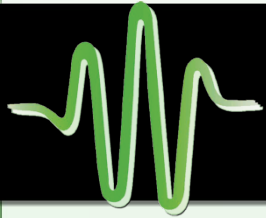

WHY56ND Temperature Controller

GENERAL PURPOSE TEMPERATURE CONTROLLER

The WHY56ND is a general purpose analog controller driving up to ± 2.2 Amps for use with thermoelectric or resistive heater applications.

The WHY56ND uses an active resistor bridge circuit that operates directly with thermistors or RTD temperature sensors. A single resistor or trimpot sets the temperature setpoint, and with additional circuitry an external voltage signal can be used.

Multiple WHY56ND units can be tied together to drive higher output currents. Independent heat and cool current limits are set by single resistors. A single resistor sets proportional gain and a resistor/capacitor in series sets the integrator time constant.

SPECIFICATIONS

PARAMETER	MIN	TYP	MAX	UNIT
Controller Supply Voltage		5 to 24		VDC
Load Supply Voltage (V_s)		5 to 28		VDC
Compliance Voltage	$V_s - 1.6$	$V_s - 1$	$V_s - 0.5$	V
Max Output Current		± 2.2		A
Temperature Stability, 1 hr (10 k Ω thermistor @ 25°C)	0.001	0.005	0.01	°C

QUICK COMPARE

WTC32ND	WHY56ND
Built-in remote setpoint capability	Additional circuitry required for remote setpoint control
Supports thermistors, RTDs, AD590, LM335	Supports resistive sensors; other sensors require additional circuitry
Single-unit operation only	Multiple units can be tied together for higher output current
Minimal external electronics	Requires more external electronic components than WTC32ND

The WTC32ND is sometimes a better choice for particular applications. This table highlights the differences between the two units. If you have additional questions, or need help deciding which is ideal for you, contact an Applications Engineer.

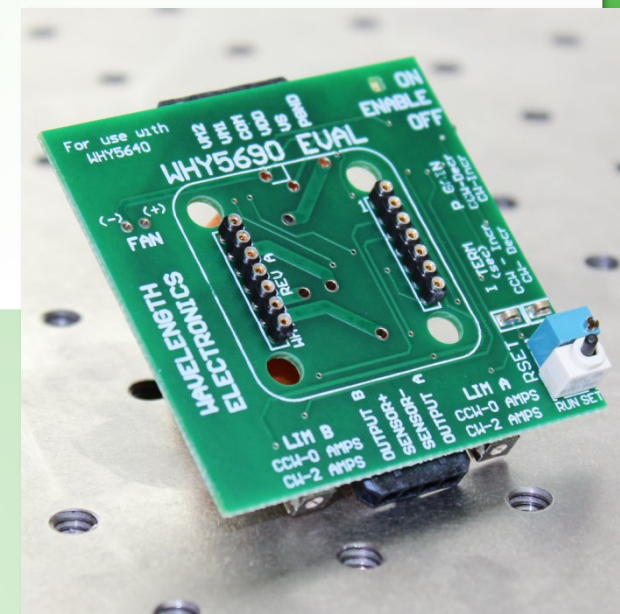

WHY56ND-EV Evaluation Board

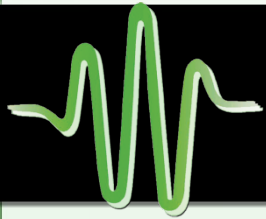

Thermistors

The TCS10K5 10 k Ω thermistor is a 1% cylindrical head option. 0.5 mm by 3 mm with 3-inch Teflon-coated leads.

The remaining thermistors are 1% bead head options — 5, 10, 20, 50 and 100 k Ω . 2 mm by 3 mm long with 3-inch Teflon-coated leads.

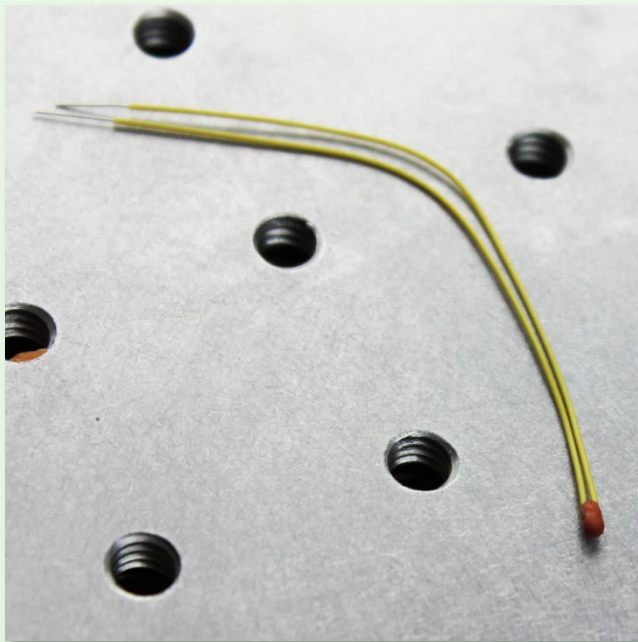
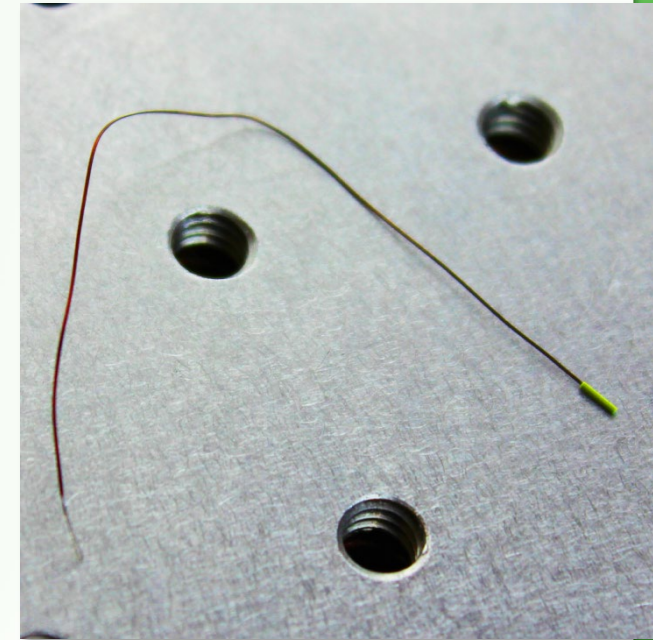

Thermistor Selection Guide

MODEL	R @ 25 °C	10 μ A RANGE	100 μ A RANGE
TCS610	10 k Ω	-45 to +13 C	-8 to +50 C
TCS10K5	10 k Ω	-45 to +13 C	-8 to +50 C
TCS620	20 k Ω	-35 to +28 C	+6 to +69 C
TCS650	50 k Ω	-18 to +49 C	+25 to +92 C
TCS651	100 k Ω	-6 to +67 C	+41 to +114 C





Power Supplies

These low profile AC/DC switching supplies provide 1% Noise & Ripple, short circuit protection, 1-3% line regulation (depending upon model), 0.04% temperature coefficient, and up to 85% efficiency.

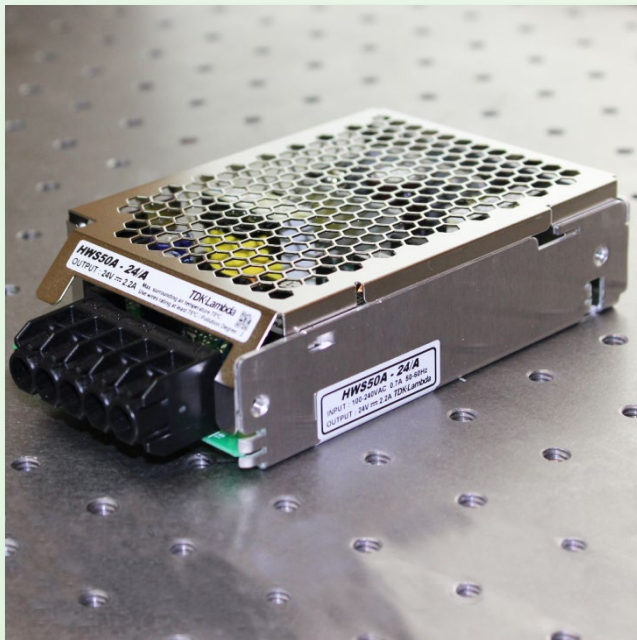



Laser Diode & Rack Mounts

Laser mount to support the most common butterfly style laser diodes. LED ON indicator, DSUBs for easy connection to a temperature controller and laser driver. Make your system plug-n-play with our 5A laser mount.

Mount one or two QCL LAB instruments, which have a 2 U height, in a standard 19" rack. Dual instruments can be mounted side-by-side. A single instrument mounts on either the left or right side.



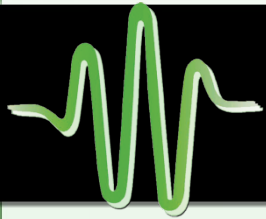

Cabling

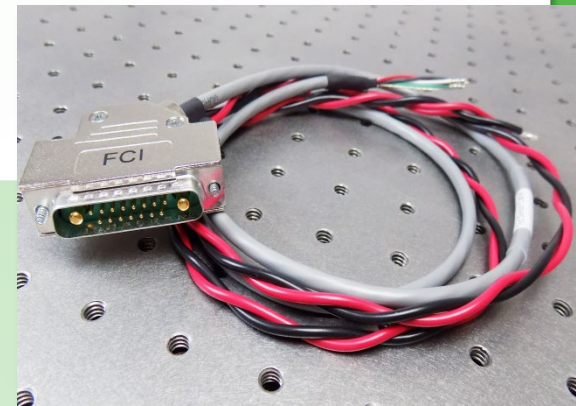
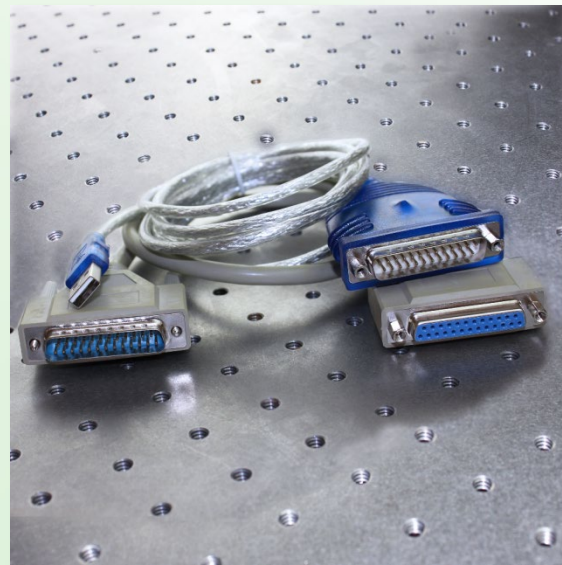
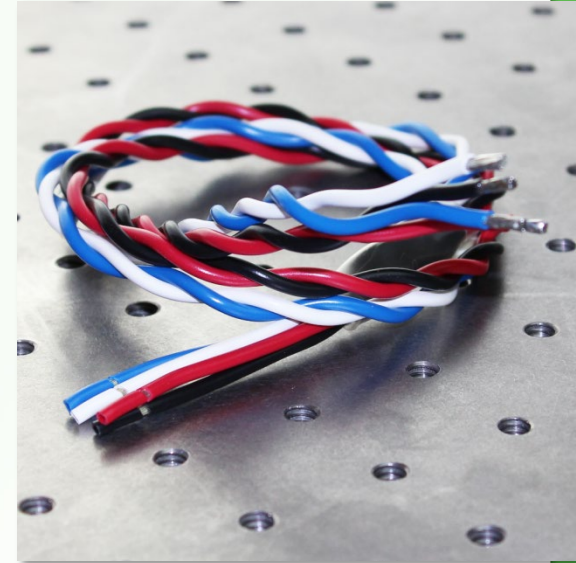



Thermal Management

The Multi-Product Heat Sinks support many Wavelength Electronics products with excellent thermal conductivity during product evaluation. Also available in a High Power option for products with drive currents over 10 A. Mounting hardware and thermal paste are included. Product specific heatsinks and thermal management kits are also available.

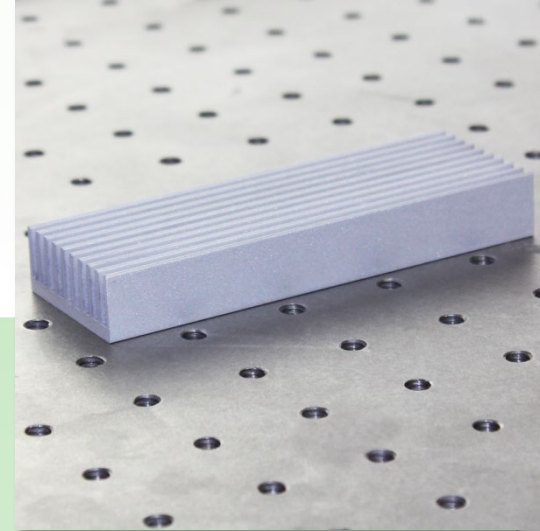
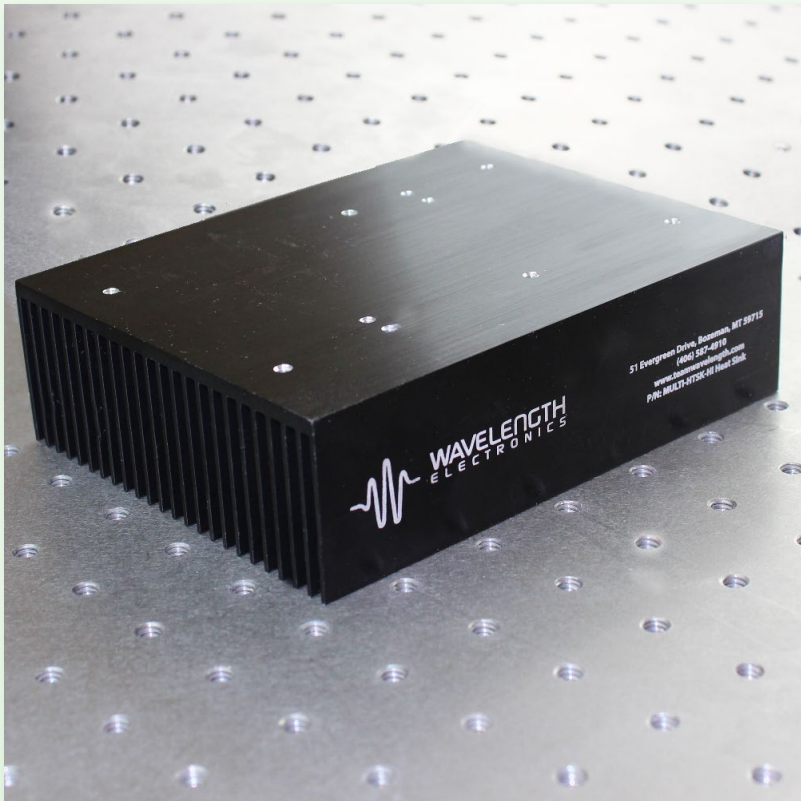
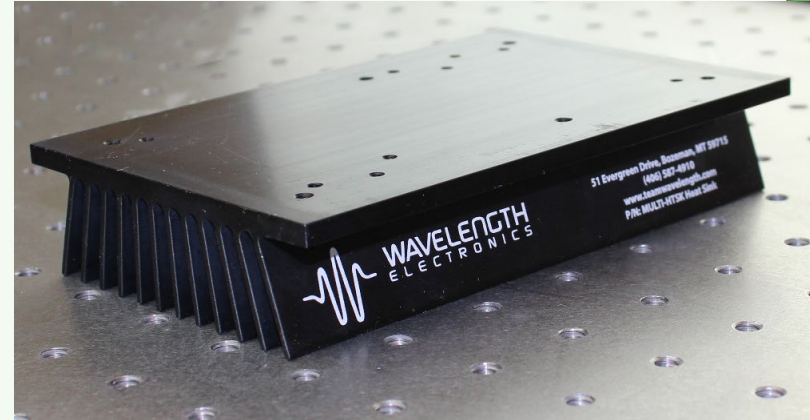

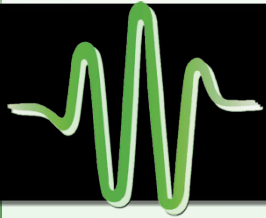

Online Design Tools

The Safe Operating Area Calculators (SOA Calculators) are used to ensure a thermally robust, reliable system using your input voltage, load size, and ambient temperature.

The WTC Series Circuit Calculator calculates gain resistor values based on thermoelectric or resistive heater currents, PI loop configuration based on load type, and sensor gain and bias current.

The WLD Series Circuit Calculator calculates the limit resistor, PD sense resistor, and LD sense resistor values based on laser diode current limit and operating mode.

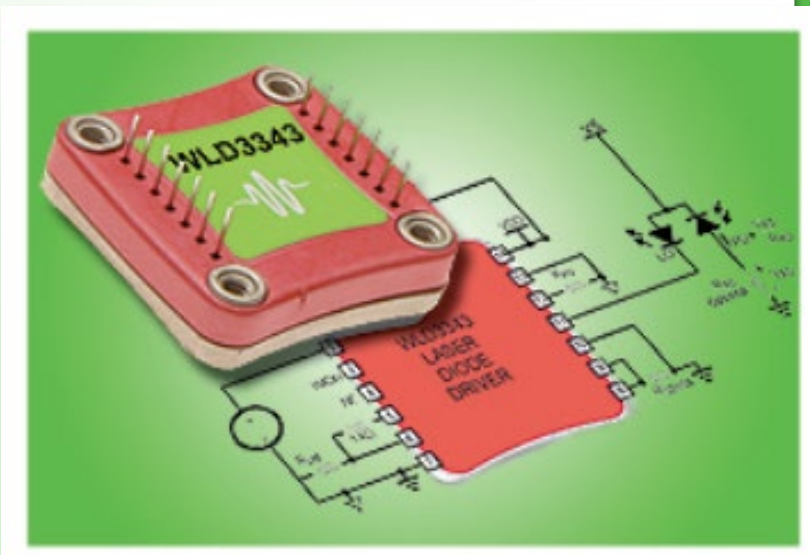
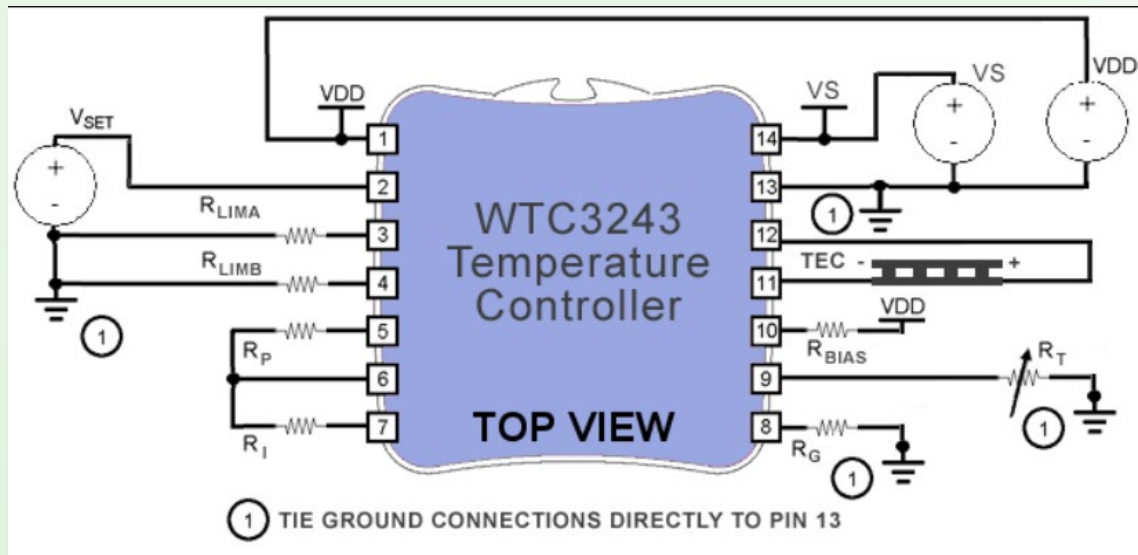
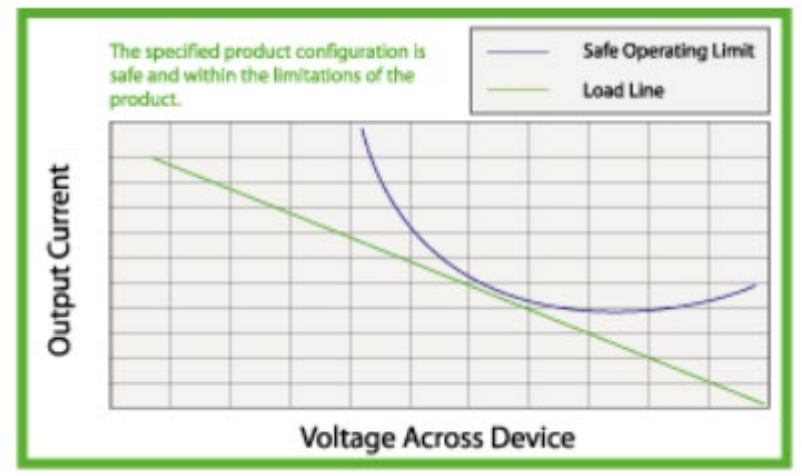

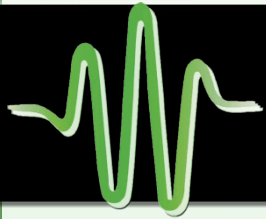

Applications

- QCLs for Gas Sensing in the Mid-IR
- Optoelectronic Qualification: NASA Goddard
- Raman Spectroscopy: Complete Laser Control
- Telecomm Manufacturing
- Medical Lasers
- Portable Shifted Excitation Raman Difference Spectrometer For In-Situ Field Measurements
- Methane Detection Using Unmanned Aerial Systems
- Utilizing Quantum Dots to Label DNA
- Trace Atmospheric Gas Sensing with QCLs

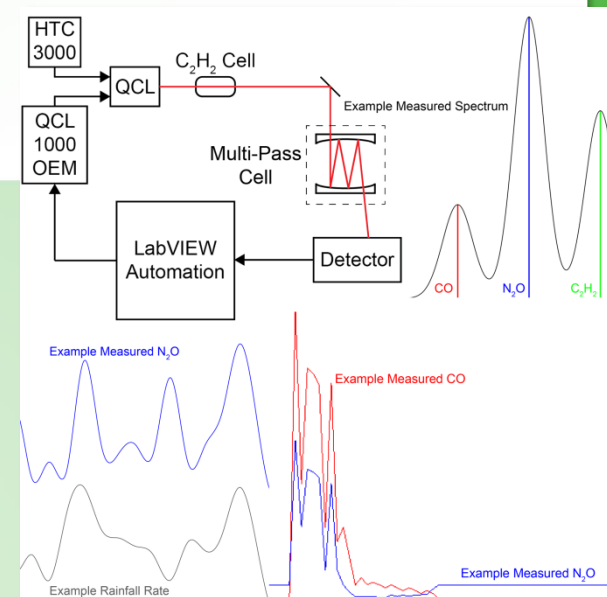
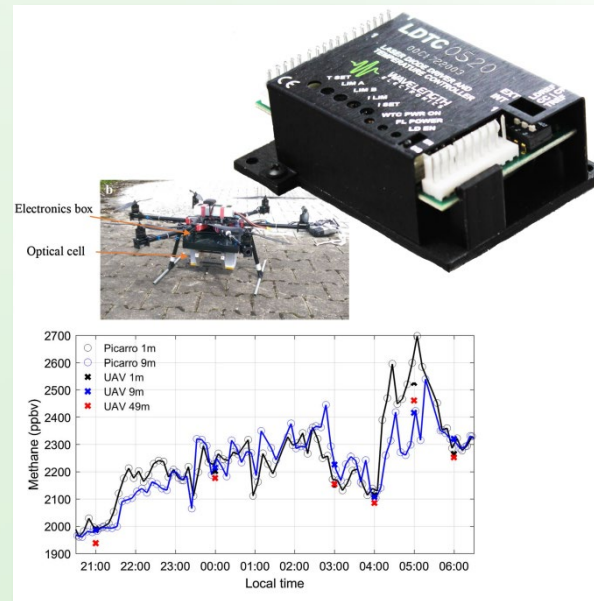
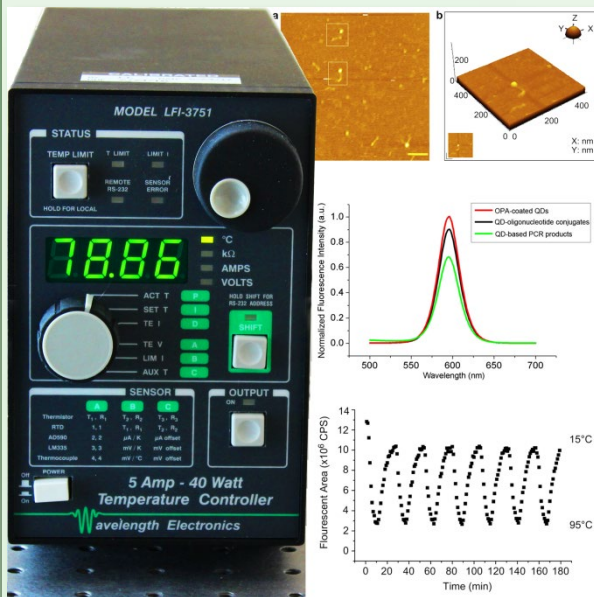
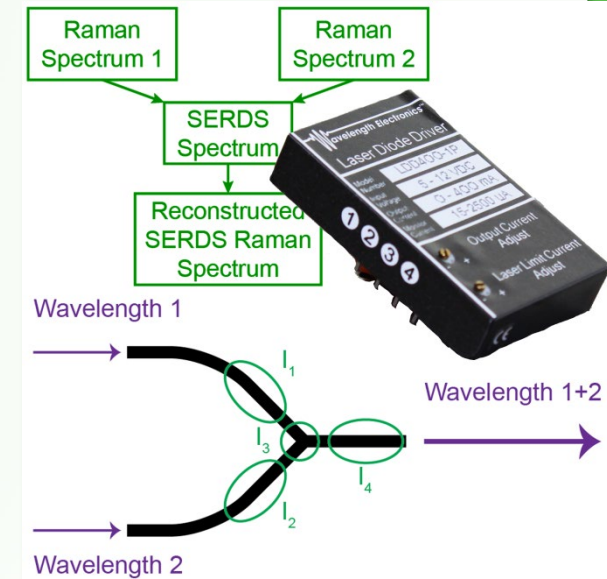

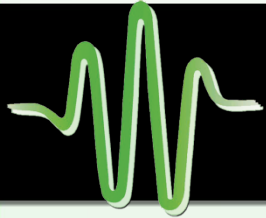

WAVELENGTH
ELECTRONICS

www.teamwavelength.com

sales@teamwavelength.com

(406) 587-4910